

Packaging Solutions

BANNER[®]
more sensors, more solutions







Contents

Industry 4.0	4
Solutions by Industry	
Food	9
Beverage	15
Consumer Packaged Goods	23
Pharmaceutical	29
Remote Monitoring	35
Products	39

Industry 4.0

What IIoT Means for Manufacturing

IIoT is perhaps the biggest buzzword in factory automation today, and it is a key aspect of Industry 4.0. IIoT already impacts the way factories operate today, and it will increasingly impact businesses in the future.

Industry 4.0, IoT, and IIoT

Industry 4.0 describes the current wave of technological innovation as an era in history characterized by interconnectivity enabled by the internet and wirelessly-connected devices. While digital technologies enable the collection of large amounts of valuable data, this data primarily exists in silos that are not easily accessible for analysis and actionable insights.

The technologies of Industry 4.0 make data readily available and automate the communication between industrial automation equipment and systems. This enables predictive analysis for machines as well as process optimization across the factory floor.

The **Internet of Things (IoT)** describes the technologies that connect objects—from consumer electronics to industrial components—to the internet. The **Industrial Internet of Things** (or IIoT) refers specifically to the impact of this innovation on industrial applications.

The key benefits of IIoT technologies for factory automation include:

- Visibility and Remote Access to the operational status of machine components (both historically and in real-time)
- Predictive Analytics for more accurate planning of machine maintenance
- Interconnectivity for seamless communication among machines, components, and people

What Does IIoT Mean For Factories?

Following are three practical examples of how visibility, predictive analytics, and interconnectivity are impacting factories today.

Visibility and Remote Access Increase Efficiency

In order to ensure efficient processes throughout the factory, machine operators must quickly and easily determine the status of machines. The greater the visibility, the easier it is to identify and resolve problems and keep operations running smoothly.

Traditional tower lights provide visibility wherever they can be physically seen. However, tower lights equipped with wireless communication capabilities both display a visual indication of an event and transmit wireless alerts. This helps ensure that operational problems are identified and addressed

immediately, regardless of whether a machine operator is physically present to see the visual indicator.

An additional benefit of wireless indicators is data logging for use in OEE (Overall Equipment Effectiveness) calculations. Not only can operators respond to alerts quickly as they occur, but a history of alerts can also be stored and analyzed offline. This historical data can be used to track machine uptime, production volume, rejected parts, and other key metrics to make more informed decisions over time.

Predictive Maintenance Increases Machine Uptime and Availability

In addition to real-time status monitoring, IIoT technologies can also be used to help avoid machine failures thanks to predictive maintenance.

By monitoring machine components in real-time for increases in vibration and temperature, problems can be detected and resolved before they become too severe and cause additional damage or result in unplanned downtime. Over time, the historical data creates a valuable machine performance log that can be used to make more informed maintenance decisions down the line.

Interconnectivity Streamlines Factory Communications

Wireless technologies also enable seamless interaction among human workers, and can have a significant impact on the efficiency of manual

production lines. For example, instead of requiring machine operators to walk over to the manager area for assistance with a technical issue, a wireless system utilizing connected pushbuttons or switches and tower lights can be used to alert managers when assistance is needed on the line.

Is Your Business IIoT-Ready?

From keeping machines running smoothly to enabling seamless communication among machines, components, and people, the benefits of IIoT technologies are tangible. However, it can be challenging knowing where to start and how to use these technologies to their fullest advantage.

Below are three questions to help manufacturers prepare for a move from digital to IIoT:

- What are the inefficiencies in your operations?
- What kind of data would help you overcome these inefficiencies?
- What communication processes need to be in place in order to utilize data in a meaningful way?

Answering these questions can help manufacturing facilities identify the best technologies to meet their immediate business needs and start taking advantage of the long-term benefits of IIoT.



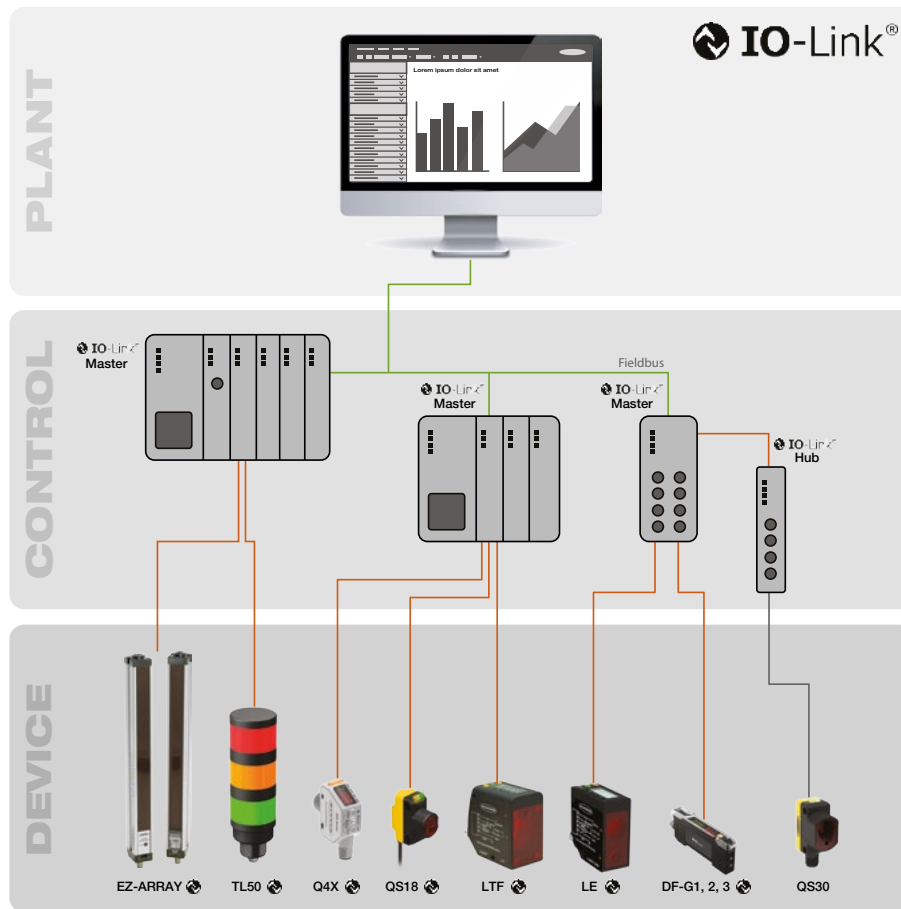

What is IO-Link?

IO-Link (IEC61131-9) is an open standard serial communication protocol that allows for the bi-directional exchange of data from sensors and devices that support IO-Link and are connected to a master. The IO-Link master can transmit this data over various networks, fieldbuses, or backplane buses, making the data accessible for immediate action or long-term analysis via an industrial information system (PLC, HMI, etc.). Each IO-Link sensor has an IODD (IO Device Description) file that describes the device and its IO-Link capabilities.

5 Advantages of IO-Link

1. Standardized and Reduced Wiring

IO-Link devices do not require any special or complicated wiring, but can be connected using the same cost-effective standard unshielded 3-wire cables as conventional discrete I/O. In addition, IO-Link also eliminates the need for analog sensors and reduces the variety of cord sets required for sensors, which saves inventory costs. IO-Link also supports a master-slave configuration with passive connection points, which further reduces wiring requirements.

2. Increased Data Availability

Access to sensor-level data helps ensure the smooth operation of system components, streamlines device replacement, and enables optimized machine maintenance schedules—all of which save costs and reduce the risk of machine downtime.

This wealth of valuable data made available through IO-Link is integral for the Industrial Internet of Things (IIoT) and Industry 4.0 initiatives.

3. Remote Configuration and Monitoring

With IO-Link, users can read and change device parameters through the control system software, enabling fast configuration and commissioning that saves time and resources. In addition, IO-Link allows operators to dynamically change the sensor parameters from the control system as needed—such as in the case of product changeover—which reduces downtime and allows machines to accommodate greater product diversity.

In addition, the ability to monitor sensor outputs, receive real-time status alerts, and adjust settings from virtually anywhere allows users to identify and resolve problems that arise on the sensor level in a timely manner. This capability reduces costly downtime and improves overall efficiencies.

4. Simple Device Replacement

In addition to the ability to remotely adjust sensor settings, IO-Link's data storage capability also allows for automated parameter reassignment in case of device replacement (also known as Auto-Device Replacement or ADR). Users can import existing sensor parameter values into a replacement sensor for seamless replacement, getting the new device up and running as quickly as possible.

5. Extended Diagnostics

IO-Link provides users with visibility into errors and health status from each device. This means that users can see not only what the sensor is doing but also how well it is performing—a valuable insight into a machine's efficiency. In addition, extended diagnostics allow users to easily identify when a sensor is malfunctioning and diagnose the problem without shutting down the line or machine.

The combination of real-time and historic data not only reduces troubleshooting efforts as issues arise but also allows for optimization of machine maintenance schedules, saving costs and increasing efficiency in the long term.

Industry Challenges

- Unplanned Downtime
- Wash Down Environment
- Frequent Product Changeover
- Machine Troubleshooting
- Detecting Challenging Packaging material
- Safeguarding Complex machines
- Predictive Maintenance
- Data and Analytics
- Food Safety Regulations
- Track and Trace



Banner Engineering is Developing Products to meet these Challenges:



IO-Link Communication

IO-Link is an open standard serial communication protocol that allows for the bi-directional exchange of data from sensors and devices that support IO-Link and are connected to a master. The IO-Link master can transmit this data over various networks, fieldbuses, or backplane buses, making the data accessible for immediate action or long-term analysis via an industrial information system (PLC, HMI, etc). Banner IO-Link products reduce wiring, increase data availability, enable remote configuration and monitoring, simplify device replacement, and provide extended diagnostics.



Safety Products that meet Cat 4 PLe

Protecting employees at your work place is a high priority and that is why Banner designs our safety components to the highest safety ratings in the market.



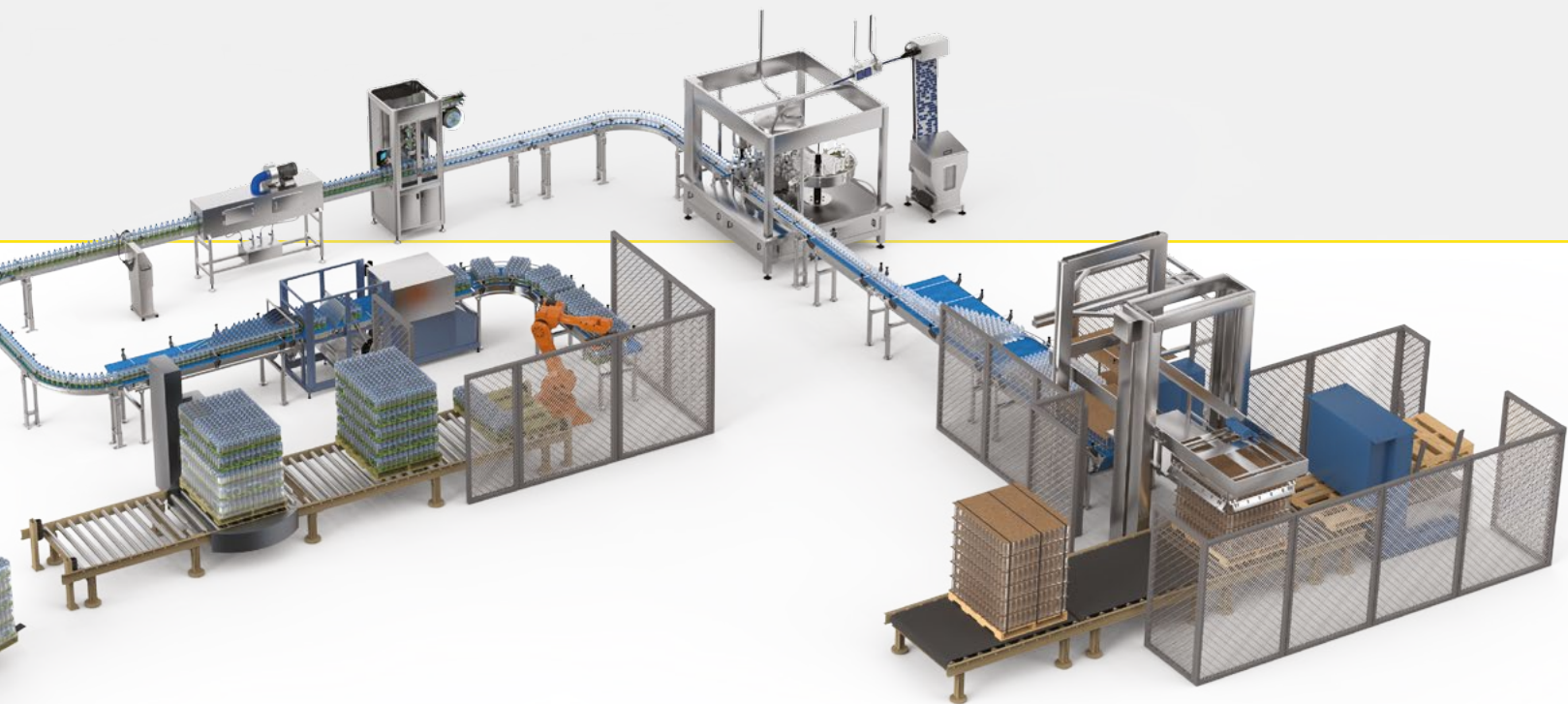

Ecolab Certified

Many manufactures use a mixture of cleaning chemicals to prevent the growth of bacteria on their equipment. Banner takes this into consideration when selecting housing and window materials for our products for food and beverage industries. Ecolab Certification means the Banner product is robust when exposed to cleaning chemicals and will hold up well to regular cleaning.



FDA Compliant Materials

In the manufacturing process it is possible for food or beverages to come in contact with components on the line during the processing, packaging, or storage process. Banner understands this concern and is developing products with housings made of FDA compliant materials.

IP69K Products

There is an increasing need in the market to develop sensors that can hold up to washdown areas and therefore Banner is developing more sensors that meet and exceed the IP69K test requirements. The IP69K rating refers to the product's ability to resist ingress of dust as well as high temperature high pressure water.

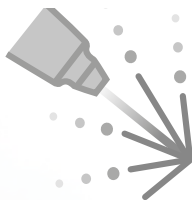

Hygienic Design

Food safety is a high priority for manufacturers today. When developing new products for the food and beverage industry, Banner takes into consideration the shape of the sensor housing. It is important for the housing shape to be self-draining to remove residues of products and chemicals during the cleaning process. The housing should also be smooth and free from crevices, sharp corners, protrusions, and shadow zones.







Packaging in the Food Industry

The food industry is the largest industry on the planet. As economies around the world continue to evolve and develop, so do the lifestyles and demands of consumers. In this highly competitive market, a company's ability to respond and adapt to these changes is critical. Changing consumer demands quickly translates to changes in products, production processes and packaging.

Banner has developed products specifically designed for the food industry. Our industry knowledge and expertise in sensors and vision sensors, LED lights and indicators, wireless networks and safety control allow us to offer solutions that address these challenges. Products and solutions from Banner help food manufacturers around the world reduce expenses, improve quality and efficiency, and increase product output and profits without compromising worker safety.

Solutions for Packaging in the Food Industry

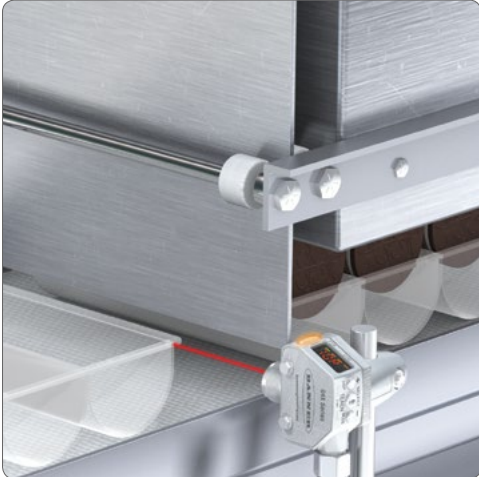

see page 43

Clear Tray Detection for Fill Trigger

Challenge

- Reliably sense transparent containers
- Suitable for harsh washdown environments

Key Features

- Algorithm uses distance and intensity for clear object detection
- FDA grade stainless steel and Ecolab certified
- IP69K
- No reflector required

Featured Solution

Q4X

Other Solutions

QM26 Clear Object Detection
QS18 Clear Object Detection



Key Benefits

- Reliably detects transparent containers no matter what shape or surface
- Holds up to chemicals used to clean equipment which reduces downtime
- Holds up to temperature cycling which occurs in high temperature and high pressure washdown
- Quick installation and the reflector is not a concern for maintenance



see page 40

Roll Diameter

Challenge

- Accurately measure roll diameter
- Targets often contain vibrant, multi-colored, graphics of varying reflectivity

Key Features

- Sub-millimeter repeatability regardless of color, reflectivity, or angle
- Factory calibrated for full scale measurement out of box
- Two-line, eight-character display

Featured Solution

LE250

Other Solutions

LE550
LTF
Q4X



Key Benefits

- Stable measurement minimizes waste left on core
- Easily deployable without need to teach specific range or empty core
- Visual feedback for easy adjustment and troubleshooting



see page 41

Hopper Fill Level Monitoring

Challenge

- Variable target size, texture, color and reflectivity
- Measuring hopper fill level while avoiding false readings from side walls

Key Features

- Best in class linearity, repeatability and resolution
- Visible red laser spot
- Two-line, eight-character display
- 12 m and 24 m range

Featured Solution

LTF

Other Solutions

LE550
QT50U



Key Benefits

- Accurate readings regardless of color, texture, or angle of target
- Laser spot allows for easy alignment
- Visual feedback for quick adjustment and troubleshooting
- Long range allows sensor to be out of the way of operators or for washdown

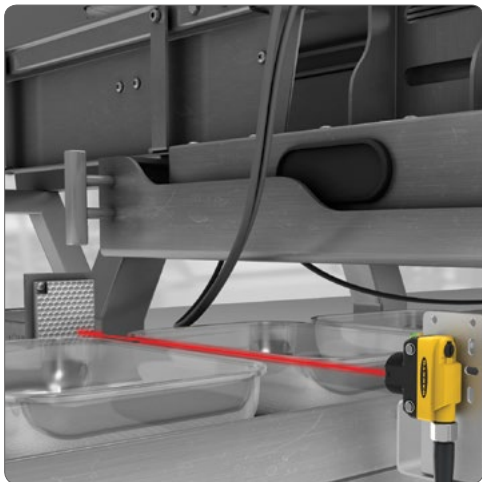

see page 45

Clear Object Detection

Challenge

- Sense leading edge of clear PET trays and clamshell packaging
- Food powder on reflector creates false outputs
- Complicated sensor set up

Key Features

- Polarized coaxial optical design
- 400 µs ON/OFF response time
- ClearTracking Algorithm
- Single push teach method

Featured Solution

QS18 Clear Object Detection

Other Solutions

Q4X



Key Benefits

- Reliably detects clear and mirror-like surfaces
- Precise leading-edge detection
- Ability to compensate for dust build-up and ensure consistent detection
- Single push teach method makes for quick and easy installation

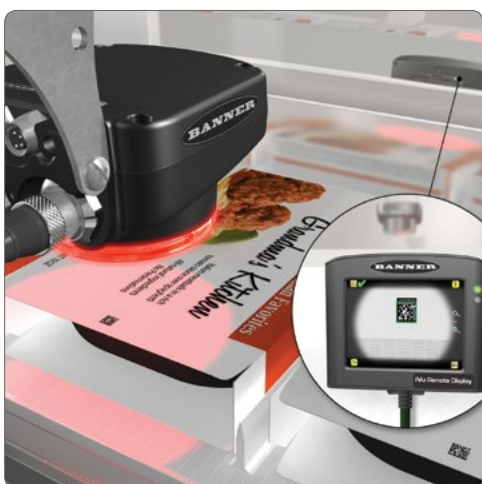

see page 64

Carton Verification

Challenge

- Ensuring the product is correctly placed in the appropriate carton
- Changeover between different products can increase downtime
- Need easy-to-use solution

Key Features

- Reads a variety of linear and 2D barcodes
- Ethernet communications
- Up to 30 stored inspections
- Configured via touchscreen

Featured Solution

IVu GEN II BCR

Other Solutions

PresencePlus BCR



Key Benefits

- Robust barcode decoding
- Barcode data can be stored in PLC or set for simple pass fail
- Reduce downtime with saved inspections for different products
- No complex software minimizes necessary training for setup



see page 65

Cabinet Lighting

Challenge

- Limited space inside panel
- Dark control panel makes it difficult to troubleshoot problems

Key Features

- 15 mm profile
- Completely sealed with an IP67 rating for use in wet or dusty environments

Featured Solution

WLS15

Other Solutions

WLB32



Key Benefits

- Low profile fits in tight spaces
- Will hold up and last a long time in tough environments

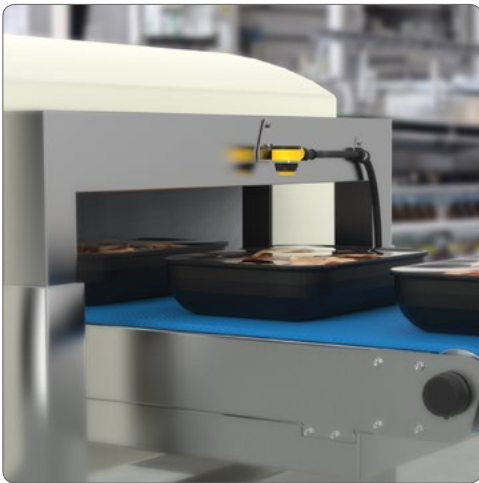

see page 47

Sensors for Wash Down Areas

Challenge

- High pressure high temperature washdown
- Harsh cleaning agents degrade housing
- Thermal cycling causes condensation

Key Features

- IP69K-rated
- Ecolab certified
- Ultrasonically welded joints
- Epoxy encapsulated

Featured Solution

T18-2

Other Solutions

Q4X



Key Benefits

- Tested to withstand 1200 PSI and 180 °F washdown
- Chemically compatible with washdown chemicals
- Ultrasonically welded joints create one piece housing
- Epoxy-filled housing reduces potential for condensation



see page 66

Machine Illumination—Washdown

Challenge

- Machine illumination in close contact with food
- Wash down area
- Food contamination hazards

Key Features

- Brilliant LED illumination in hygienic cylindrical design
- Rugged ultrasonically welded, IP69K construction and Ecolab certified
- Shatterproof copolyester housing

Featured Solution

WLS27

Other Solutions

WLS15



Key Benefits

- 50,000 hours lifetime, easy-to-clean light
- Specifically designed to withstand food and beverage industry applications
- No secondary enclosure needed to protect against broken lights



see page 77

Wash Down Touch Buttons

Challenge

- Control panel located in washdown area
- Workers use thick rubber gloves
- Food area

Key Features

- Rugged IP69K construction
- Smart electric field sensing technology
- FDA-grade models available

Featured Solution

S22 Touch



Key Benefits

- Built for high-pressure washdown environments
- Easily actuated with bare hands or work gloves
- FDA-grade models for use in food environments



Safety Light Curtain— Wash Down Area

see page 56

Challenge

- Safeguard food processing machine
- Wash down area with harsh chemicals
- Temperature cycling

Key Features

- End-to-end zone protection with no dip switches
- IP69K enclosure with 316L stainless steel end caps
- Hydrophobically vented

Featured Solution

EZ-SCREEN LS
(IP69K)



Key Benefits

- Intuitive, easy-to-use
- Build to withstand high pressure, high temperature washdown
- Air vents with vapor barriers prevent condensation during thermal cycling

E-Stop Safety— Wash Down Area

see page 58

Challenge

- Holding up to a harsh environment
- Ability to identify which E-Stop was pressed
- Assembling components is time consuming

Key Features

- IP69K rated FDA Grade Silicon cover
- Ecolab certified
- Preassembled for fast installation
- Green/Red lighted base
- 8-pin Quick-Disconnect

Featured Solution

30 mm Mount
E-Stop (IP69K)



Key Benefits

- Withstands high pressure and high temperature washdown
- Certified to withstand cleaning chemicals used in the food processing industry
- 360° visible indication of E-Stop actuation
- Easy installation with no assembly or wiring required

Safety Monitoring

see page 60

Challenge

- Safeguard machine with varying safety add-ons depending on customer needs
- Complex logic or multiple safety scenarios
- Communicate with HMI to display machine status

Key Features

- Free, easy-to-use software using drag and drop function blocks
- Simulation mode
- Expandable I/O modules
- Industrial Ethernet communications and Profinet communications

Featured Solution

XS26-2

Other Solutions

SC26-2



Key Benefits

- Configure safety program in minutes
- Test configuration without need to wire or even own safety controller
- Base controller with 26 inputs and two dual-channel safety outputs can be expanded to fit machine requirements
- Ethernet-enabled models allows for easy communications with PLC or HMI





Packaging in the Beverage Industry

Beverage production offers some of the biggest challenges in factory automation.

From severe conditions and harsh cleaning processes that can quickly degrade system components to safeguarding palletizers, conveyors, and other equipment that pose a safety hazard to personnel, each challenge works against total Overall Equipment Effectiveness (OEE) and the overall profitability of an organization.

Banner understands these challenges. Our industry knowledge, expertise in sensors, safety control, LED lights and indicators is combined the most comprehensive product catalogs in the industry. We are able to provide products and solutions that solve the unique challenges faced by beverage producers, helping them ensure and improve product quality, productivity, and safety, and achieve maximum Overall Equipment Effectiveness.

Solutions for Packaging in the Beverage Industry



see page 43

Line Pressure Control

Challenge

- Sensing bottle stoppage and shortage often requires two sensors
- On and Off-delay logic to ignore passing bottles requires additional PLC programming
- Bottles can be clear to opaque and filled or empty

Key Features

- Dual discrete output
- Programmable output logic
- Dual mode/Clear Object Detection mode

Featured Solution

Q4X Dual Discrete



Key Benefits

- One sensor solution instead of two
- On and off-delays within sensor reduce PLC programming
- Robust clear object sensing using distance and intensity changes

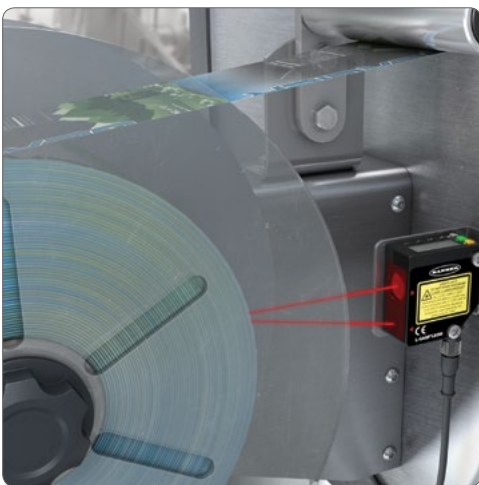

see page 40

Roll Diameter

Challenge

- Flexible packaging often contains vibrant, multi-colored graphics of varying reflectivity that can be difficult to reliably sense
- Variable roll stock diameter increases changeover time when sensors need to be adjusted

Key Features

- Laser triangulation with linear array technology
- Ready to measure full scale out of box or can be programmed with integrated LCD display

Featured Solution

LE250/550

Other Solutions

Q4X
LTF



Key Benefits

- Ensures repeatability and accuracy for challenging targets regardless of color, reflectivity, or angle
- Reduces downtime between product changeover



see page 44

Shrink Sleeve Labelling At High Speeds

Challenge

- High speed shrink sleeve applicator can run 800 bottles per minute
- Precise leading-edge sensing to center sleeve on bottle

Key Features

- 700 μ s response time
- Laser-based retroreflective sensor

Featured Solution

QS18LLP

Other Solutions

DF-G2
QS18 Clear Object Detection



Key Benefits

- Fast response time to easily keep up with bottling line
- Narrow laser beam ensures repeatable leading-edge sensing



see page 45

Clear Bottle Tipped

Challenge

- Detect downed bottles to prevent jams on filling line
- Bottles can be plastic, glass, clear or opaque

Key Features

- Single-point teach mode
- Coaxial polarized optics

Featured Solution

QS18 Clear Object Detection

Other Solutions

Q4X



Key Benefits

- Easy teach process minimizes install time
- Coaxial optics ensure reliable sensing regardless of material or opacity



see page 46

Level Fill

Challenge

- Sense liquid in bottles of various colors from clear to opaque
- Sense under-filled clear or opaque bottles

Key Features

- 1450 nm wavelength detects water-based liquids inside translucent or opaque plastic and glass bottles
- Use of apertures to decrease the minimum detectable change in liquid level

Featured Solution

QS30H2O

Other Solutions

DF-G3LIR



Key Benefits

- See through bottles and detect water-based liquids
- Under-filled bottles can be removed from bottling line



see page 64

Data Code Presence

Challenge

- Laser etched date code changes regularly
- Product changeover requires parameter changes without connecting to a PC

Key Features

- Easy-to-use toolset
- Integral and remote screen for configuration and troubleshooting
- Save and store 30 inspections

Featured Solution

iVu Plus BCR Gen2

Other Solutions

VE
P4 Omni



Key Benefits

- Quickly create barcode inspection
- No computer software needed for setup
- Save inspections for quick product changeover



see page 42

Registration Mark on Shrink Sleeve Label

Challenge

- Repeatable sensing of registration mark
- Registration mark colors vary depending on product
- Shiny, high-gloss labels

Key Features

- 50 μ s response time
- RGB LED
- Smart gain-control algorithm

Featured Solution

R58E

Other Solutions

R55F



Key Benefits

- Quick response time ensures repeatable sleeve length
- RGB LED optimizes contrast
- Smart gain-control maximizes performance on low-contrast or high-gloss applications

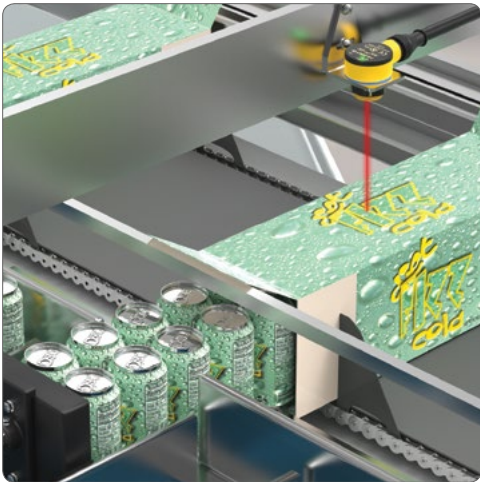

see page 47

Sensors for Wash Down Areas

Challenge

- Case packers are subject to washdown procedures
- Cases are often multicolored and have a glossy finish

Key Features

- IP69K, FDA-grade materials
- Ultrasonically welded housing and epoxy encapsulated cavities
- High excess gain

Featured Solution

T18-2

Other Solutions

M18-4



Key Benefits

- Built to withstand high-pressure, high-temperature washdown
- One-piece construction eliminates adhesives and effectively seals out moisture
- Minimal color sensitivity prevents chattering output on difficult targets



see page 66

Machine Illumination—Washdown

Challenge

- Enclosed area is dark, making it hard for operators to see potential problems
- Filler machine is subject to washdown procedures
- Secondary lighting enclosure to protect against broken pieces

Key Features

- Bright LED illumination rated for 50k hours
- Hygienic, IP69K, Ecolab certified housing
- Shatterproof copolyester shell

Featured Solution

WLS27

Other Solutions

WLS28-2



Key Benefits

- Long lasting LED lights require minimal maintenance
- Rugged design stands up to demanding washdown procedures
- Shatterproof housing can be installed directly inside the machine without worry



see page 77

Wash Down Touch Buttons

Challenge

- Control panel located in washdown area
- Workers use thick rubber gloves
- Food area

Key Features

- Rugged, fully encapsulated IP69K construction
- Smart electric field sensing
- FDA-grade models available

Featured Solution

S22 Touch



Key Benefits

- Built for high-pressure washdown environments
- Easily actuated with bare hands or work gloves
- FDA-grade models for use in food environments



see page 65

Cabinet Lighting

Challenge

- Limited space inside panel
- Dark control panel makes it difficult to troubleshoot problems

Key Features

- 15 mm profile
- Completely sealed with an IP67 rating for use in wet or dusty environments

Featured Solution

WLS15



Other Solutions

WLB32

Key Benefits

- Low profile fits in tight spaces
- Will hold up and last a long time in tough environments



see page 72

Machine Indication

Challenge

- Ability to easily see indicator status from all angles in high ambient light conditions
- Machines use combination of AC and DC power sources
- Installation/Assembly time

Key Features

- Constructed with white windows with high intensity LED's
- AC and DC power options available
- Audible options
- Preassembled models

Featured Solution

TL50

Other Solutions

TL70



Key Benefits

- High visibility of on and off states
- Flexibility to work with machines regardless of power supply
- Fast installation as no assembly is required

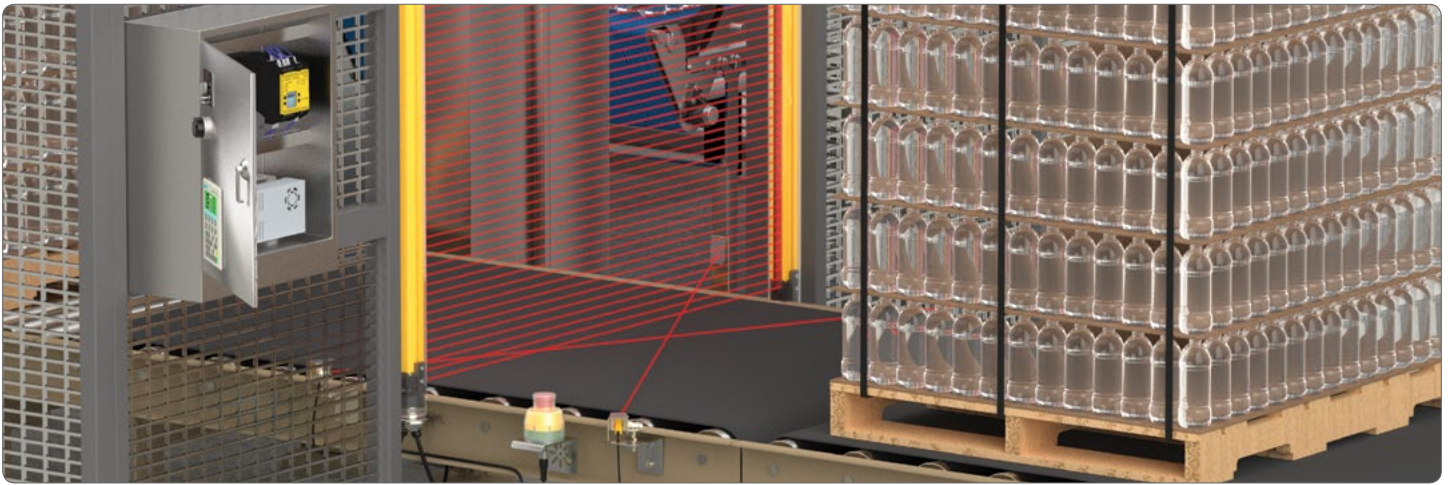

Safety Monitoring see page 60

Challenge

- Safeguard machine with variable safety add-ons depending on customer needs
- Complex logic or multiple safety scenarios
- Communicate with HMI to display machine status

Key Features

- Free, easy-to-use software using drag and drop function blocks
- Simulation mode
- Expandable I/O modules
- Ethernet and Profinet communications

Featured Solution

XS26-2

Other Solutions

SC26-2



Key Benefits

- Configure safety program in minutes
- Test configuration without need to wire or even own safety controller
- Base controller with 26 inputs and two dual-channel safety outputs can be expanded to fit machine requirements
- Ethernet-enabled models allow for easy communications with PLC or HMI

Safety Light Curtain— Wash Down Area see page 56

Challenge

- Safeguard beverage palletizer
- Wash down area with harsh chemicals
- Temperature cycling

Key Features

- End-to-end zone protection with no dip switches
- IP69K enclosure with 316L stainless steel end caps
- Air vent with vapor barrier

Featured Solution

EZ SCREEN LS
(IP69K)



Key Benefits

- Intuitive, easy-to-use safety light curtains
- Built to withstand high pressure high temperature washdown
- Air vents with vapor barriers prevent condensation during thermal cycling

E-Stop Safety— Wash Down Area see page 58

Challenge

- Harsh environment with high pressure washdown
- Difficult to tell what E-Stop is pressed when wired in series
- Modular systems are time consuming to install

Key Features

- IP69K rated FDA Grade Silicon cover
- Ecolab certified
- Green/Red lighted base
- 8-pin Quick-Disconnect

Featured Solution

30 mm Mount
E-Stop (IP69K)



Key Benefits

- Withstands high pressure and high temperature washdown
- Certified to withstand cleaning chemicals used in the food processing industry
- 360° visible indication of E-Stop actuation
- Easy installation with no assembly or wiring required





Packaging in Consumer Goods

From stand-up pouches packed in bliss boxes to plastic clam shells shrink-wrapped together, the size, shape and materials used to package a product are becoming increasingly diverse. To accommodate this diversity, packaging automation is becoming more intelligent to support a greater number of SKUs on production lines. With the accelerating pace of packaging automation comes greater need to safeguard packaging equipment.

Solutions for Packaging in Consumer Goods Industry



see page 43

Shiny Product Detection

Challenge

- Reflective, irregular shaped objects can cause erratic and inconsistent readings
- No gap between products as they come down the conveyor
- PLCs with slow scan times may not keep up with high speed lines

Key Features

- High excess gain and dynamically adjusted laser power
- Built-in Foreground Suppression Mode
- On-delay and off-delay logic built into sensor

Featured Solution

Q4X

Other Solutions

LTF



Key Benefits

- Excess gain and dynamic laser power allows the sensor to reliably measure shiny objects at steep angles
- Foreground Suppression Mode allows a sensing window to be set on the apex of the container as it passes by
- Built-in on and off-delays can extend output time

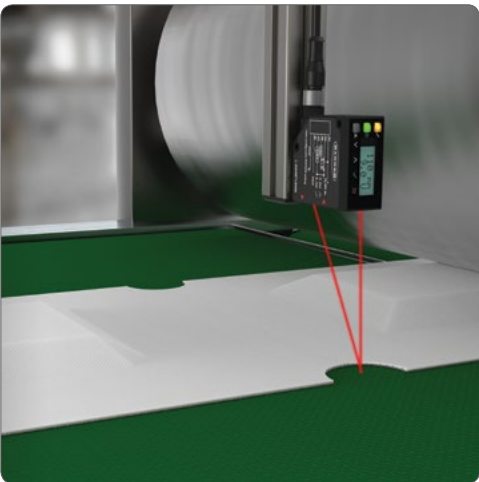

see page 40

Material Thickness—Diaper

Challenge

- Control thickness of absorbent material
- Porous or uneven material causes erratic reading
- Quickly change measurement range for product changeover

Key Features

- Laser triangulation distance measurement
- Advanced measurement algorithms
- Two-line, eight-character display with pushbutton programming

Featured Solution

LE 550/250

Other Solutions

Q4X



Key Benefits

- Repeatable and accurate measurements regardless of target's color or texture
- Perform average, max/min, measurement range readings instead of a single point measurement
- Easy setup, troubleshooting, and real-time feedback



see page 41

Roll Diameter

Challenge

- Accurately measure roll diameter of various materials
- Large parent rolls of material
- Easy to setup without need to present full/empty roll

Key Features

- Repeatable sensing regardless of texture, color, or angle of target
- 12 m and 24 m ranges available
- Two-line, eight-character display with push button input

Featured Solution

LTF

Other Solutions

LE550



Key Benefits

- Accurate measurement reduces waste left on the core
- Long ranges for large rolls and easy alignment with visible laser spot
- Pushbutton interface allows for easy setup, adjustment, and troubleshooting

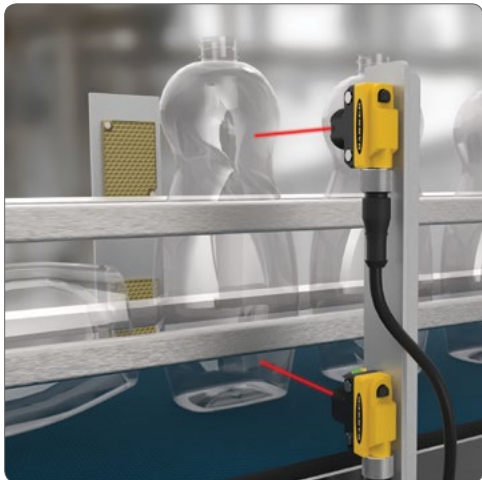

see page 45

Clear Object Detection

Challenge

- Two sensors used to sense down bottle and prevent jams on filling line
- Containers can be plastic, glass, clear or opaque

Key Features

- Single-point teach mode
- Coaxial polarized optics

Featured Solution

QS18 Clear Object Detection

Other Solutions

Q4X



Key Benefits

- Easy teach process minimizes install time
- Coaxial optics ensure reliable sensing regardless of material or opacity

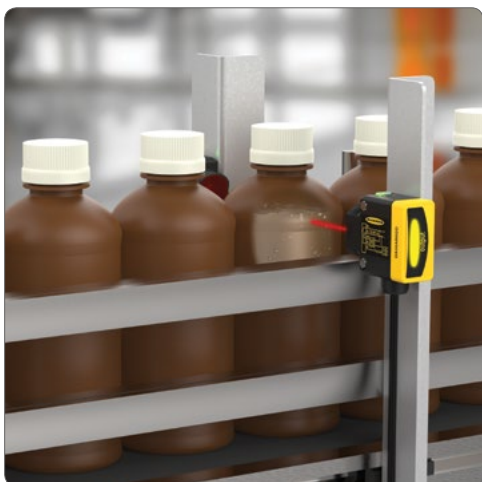

see page 46

Fill Level

Challenge

- Sense underfilled bottles through an opaque container
- Need to see through plastic bottle, but not clear liquid inside
- Repeatable level control

Key Features

- 1450 nm wavelength LED emitter
- 8 m model QS30H2O sensor
- Apertures available

Featured Solution

QS30H2O

Other Solutions

DF-G3LIR



Key Benefits

- Special wavelength that cannot see through water-based liquids
- Long range sensor can see through bottles, but not water-based liquid inside
- Use of apertures narrow the effective beam for precise fill level

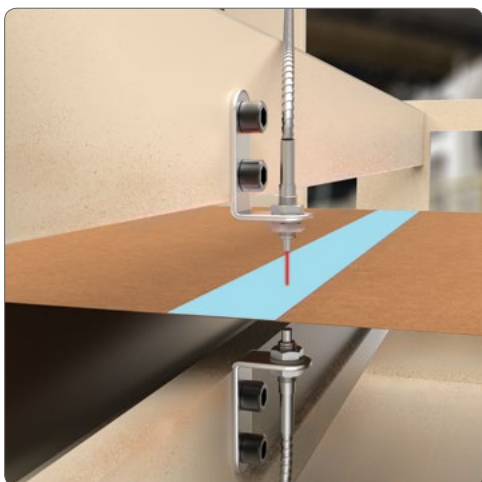

see page 48

Web Monitoring/ Splice Detection

Challenge

- Material texture and transparency vary
- Dusty environment
- Easy setup

Key Features

- Variety of opposed mode fiber arrays for edge guiding
- High excess gain with auto thresholding
- Option for mid-point teach mode

Featured Solution

DF-G3



Key Benefits

- Opposed mode fiber arrays minimize effects of changing textures and transparencies
- Able to burn through dust and compensate for dust that settles on fibers
- Mid-point teach learns the optimal web position with an easy single-point teach



see page 62

Label and Cap Verification

Challenge

- Ensure cap integrity, label verification and bottle orientation before case packer
- High product changeover
- Vision systems can be complex and require computer software

Key Features

- Multiple vision tools in one inspection
- Save up to 30 inspections
- Configuration via integrated or remote display

Featured Solution

iVu Plus TG Gen2

Other Solutions

VE



Key Benefits

- One iVu vision sensor can inspect both cap and label using easy-to-use Match tool
- Preconfigured inspections reduce downtime between product changeovers
- No complex software to learn, easily troubleshoot problems through integral or remote screen



see page 70

Visual Web Inspection

Challenge

- Operator visually inspects web of non-woven material for holes or thin spots
- Product changeover and operator changes require easy adjustability to get proper contrast
- Fluorescent lights require maintenance and risk of broken glass

Key Features

- Bright, uniform light
- Dimming capable via potentiometer or remote input
- Rugged metal housing, shatterproof light cover, long-lasting energy-efficient LEDs

Featured Solution

WLB92

Other Solutions

WLB32



Key Benefits

- Uniform light acts as backlight to see thin spots on web
- Easily dimmable to accommodate operator preferences and product changes
- Industrial-grade design provides maintenance-free illumination



see page 65

Cabinet Lighting

Challenge

- Limited space inside panel
- Dark control panel makes it difficult to troubleshoot problems

Key Features

- 15 mm profile
- Completely sealed with an IP67 rating for use in wet or dusty environments

Featured Solution

WLS15

Other Solutions

WLB32



Key Benefits

- Low profile fits in tight spaces
- Will hold up and last a long time in tough environments



E-Stop Safety

see page 58

Challenge

- Many E-stops in series make it difficult to tell which one is pressed
- Modular systems are time consuming to install

Key Features

- Green/Red lighted base
- 8-pin Quick-Disconnect

Featured Solution

30 mm Mount
E-Stop



Other Solutions

Key Benefits

- 360 visible indication of E-Stop actuation reduces downtime
- Easy installation with no assembly or wiring required

Safety Light Curtain

see page 56

Challenge

- Safeguard palletizing machine
- Alignment of light curtains over large span
- In an area where accidental impact can occur and cause damage

Key Features

- End-to-end zone protection with no dip switches
- Bi-color alignment indicators
- Metal end caps, this aluminum housing with 5 mm recessed window

Featured Solution

EZ-SCREEN LS

Other Solutions

EZ-SCREEN LP



Key Benefits

- Intuitive, easy-to-use safety light curtains
- Highly visible indicators streamline alignment process and facilitate easy troubleshooting
- Heavy duty housing to avoid damage from impact

Safety Monitoring

see page 60

Challenge

- Safeguard machine with variable safety add-ons depending on customer needs
- Complex logic or multiple safety scenarios
- Communicate with HMI to display machine status

Key Features

- Free, easy-to-use software using drag and drop function blocks
- Simulation mode
- Expandable I/O modules
- Ethernet and Profinet communications

Featured Solution

XS26-2 Safety
Controller



Other Solutions

SC26-2

Key Benefits

- Configure safety program in minutes
- Test configuration without need to wire or purchase safety controller
- Base controller with 26 inputs and two dual-channel safety outputs can be expanded to fit machine requirements
- Ethernet-enabled models allows for easy communications with PLC or HMI





Packaging in the Pharmaceutical Industry

Around the world, companies operating in the pharmaceutical manufacturing industries rely on Banner Engineering for our industry knowledge, experience and expertise to provide products and solutions that improve automation efficiency, maintain product quality, and protect operator safety.

Banner is an expert in advanced optics, LED, laser, and photoelectric circuits, offering sensors for tablet fill level monitoring and count verification, cap and closure inspection, print and label verification, and product identification and serialization. We have the industry's most complete family of safeguarding devices, allowing customers to design the highest level of safety into a machine, without compromising productivity. LED products from Banner provide clear status indication and bright, uniform illumination for machines, processes and workstations. We have a complete line-up of actuators, ideal for medical assembly, medical kitting and storage retrieval systems.

Solutions for Packaging in the Pharmaceutical Industry



see page 43

Clear Vial Detection

Challenge

- Reliably sense different vials of varying sizes, transparencies, and materials without a retroreflector
- Exposure to sterilizing chemicals

Key Features

- Algorithm uses distance and intensity for clear object detection
- FDA grade 316 Stainless Steel housing that is IP69K washdown rated and Ecolab certified

Featured Solution

Q4X (flush front)

Other Solutions

QM26 Clear Object Detection

QS18 Clear Object Detection

Key Benefits

- Reliably detect transparent objects without a reflector
- Reduced downtime from reflectors fogging up
- Reduced unscheduled down time from mechanical failure due to the SIP environment



see page 43

Vibratory Feeder – Stopper Fill Level

Challenge

- Prevent frequent start/stops
- Reliably detect stoppers of different colors, sizes, and shapes

Key Features

- Independent and adjustable on delays and off delays
- Reliably measure distance regardless of the surface reflectivity or color

Featured Solution

Q4X

Other Solutions

Q60 (Adj. Field)

QS30 (Adj. Field)

Key Benefits

- Increase the vibratory bowl's product life by reducing the start/stop frequency by ignoring signal noise
- A single sensor and setup will work detect all stopper variations, reducing change over time

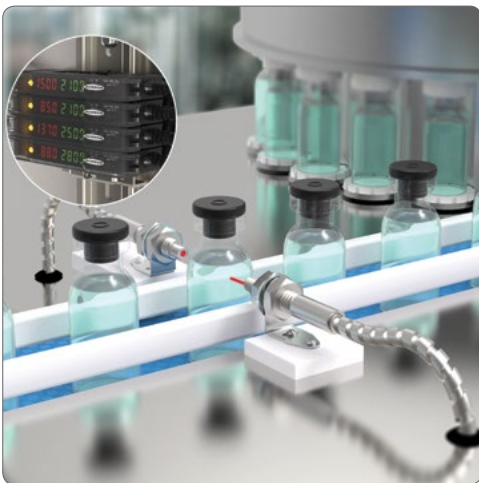

see page 49

Liquid Level Detection

Challenge

- Detect liquid level in different color vials and bottles
- Limited space to mount a sensor

Key Features

- Detect water-based liquids inside translucent or opaque plastic and glass containers
- Compatible with standard glass fibers

Featured Solution

DF-G3LIR Water sensor with a pair of IT43ST5-VL fiber optic bundle and L2 Lens

Other Solutions

QS30H20

Key Benefits

- Reduce product waste by detecting underfilled vials early in the packaging process
- Quick and simple installation with many small fiber optic bundles styles to choose from



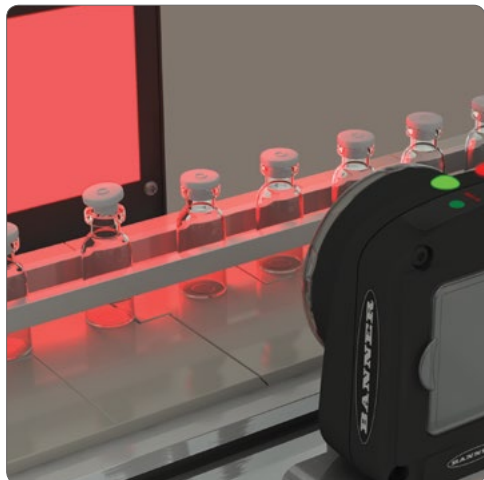

see page 62

Raised/Missing Stopper inspection

Challenge

- The height of the vials can vary
- Do not want to support a complex "vision system"

Key Features

- Find and inspect key features
- Integral and Remote Touch Screen for programming

Featured Solution

iVu Plus TG Gen2

Other Solutions

VE
Q4X



Key Benefits

- No need to mechanically move the iVu Plus when the height of the vial changes, which reduces downtime
- Easy configuration without a PC reduces setup time



see page 64

Label Verification

Challenge

- Position and type of the barcode on the label varies between product SKUs
- Ability to view inspection status without connecting to a PC

Key Features

- Imager-based barcode reader can read all the standard 1D and 2D barcodes within the sensing window
- Integral and Remote Touch Screen for configuring and viewing captured images

Featured Solution

iVu Plus BCR Gen2

Other Solutions

PresencePLUS OMNI
TCNM Barcode Reader



Key Benefits

- No required mechanical adjustments reduces changeover times
- Reduce unplanned down time by making all the necessary adjustment right on the integrated touch screen



see page 66

Machine Illumination and Status Indication

Challenge

- Easily identify when the machine requires an operator intervention
- Hygienic requirements and shatterproof design inside a packaging area

Key Features

- Ability to switch between colors from a 24 V dc input
- Encased in a shatterproof, chemically resistant, IP69K copolyester shell

Featured Solution

WLS27 (Dual Color)

Other Solutions

WLS28-2 (Dual Color)



Key Benefits

- Quickly identify the machine requiring operator intervention by illuminating the entire machine
- Reduce installation costs by installing the worklight without an additional protective housing

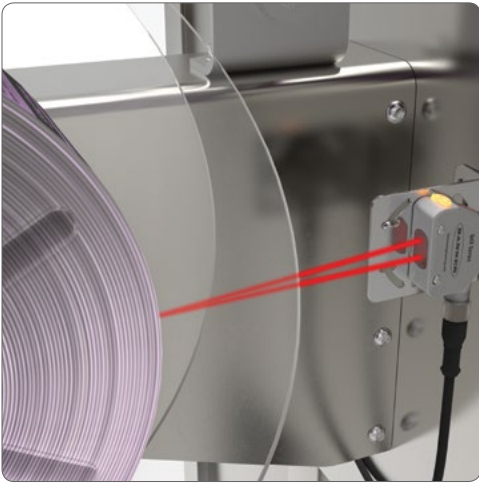

see page 43

Roll Diameter Measurement to Reduce Waste

Challenge

- Flexible packaging often contains vibrant, multi-colored, graphics of varying reflectivity that can be difficult to reliably sense
- Varying size of roll stock increases changeover time when sensors need to be adjusted

Key Features

- Uses laser triangulation with linear array technology
- Ready to measure right out of the box or can be programmed with the integrated LCD display

Featured Solution

Q4X

Other Solutions

LE250
S18U



Key Benefits

- Ensures repeatability and accuracy for challenging targets regardless of color, reflectivity, or angle
- Reduces downtime with rapid product changeovers

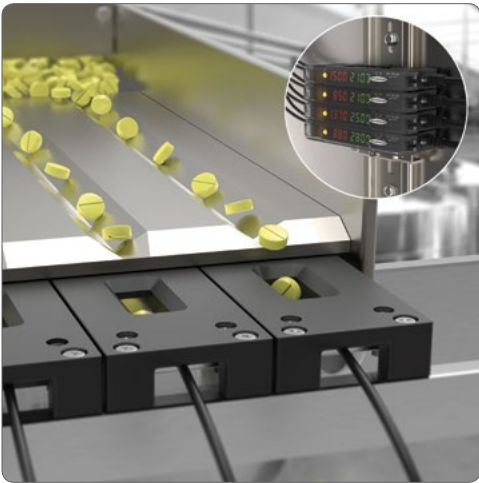

see page 48

Tablet Counting During Bottle Filling

Challenge

- Tablet dust can accumulate in the environment
- Tablet can be as small as 2 mm in diameter

Key Features

- Automatic Gain Compensation (AGC) algorithm compensates for dust build-up on fiber optics
- 40 mm fiberoptic array can detect objects as small as 2 mm

Featured Solution

DF-G3 Small Object with PGIRS66U-40 fiber

Other Solutions

D10 Amp with PFCVA-25X25-E fiber



Key Benefits

- Increase the time between scheduled maintenance by extending the counting cycle and maintain count accuracy as dust increases during production
- Improve process flexibility by detecting even the smallest tablet in a large 40 mm area



see page 61

Blister Filling Inspection

Challenge

- Partial tablets can fall into a blister cavity
- The size of the blister pack and number of blisters per pack change frequently

Key Features

- 2 megapixel imager
- Store hundreds of configurations on the VE smart camera
- Standard Ethernet communication protocols like Ethernet/IP, and FTP

Featured Solution

VE

Other Solutions

iVu Plus



Key Benefits

- Detect small defects and partial tablets
- Rapid product changeovers
- Easily export results and images to central database

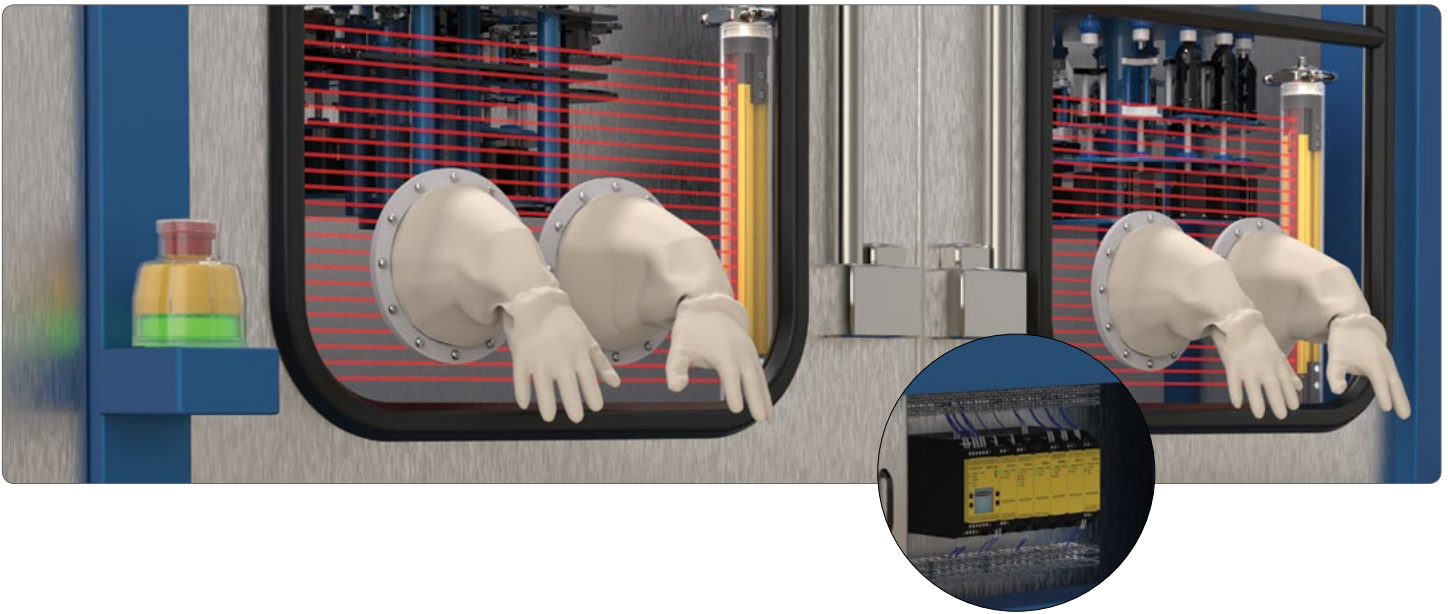

**E-Stop Safety—
Pharmaceutical Isolator** see page 58

Challenge

- Harsh environment with exposure to cleaning chemicals
- Difficult to tell what E-Stop is pressed when wired in series
- Modular systems are time consuming to install

Key Features

- IP69K FDA Grade Silicon cover
- Ecolab certified
- Green/Red lighted base
- 8-pin Quick-Disconnect

Featured Solution

30 mm Mount
E-Stop (IP69K)



Key Benefits

- Certified to withstand cleaning chemicals used in the pharmaceutical industry
- 360° visible indication of E-Stop actuation
- Easy installation with no assembly or wiring required

**Safety Light Curtain—
Pharmaceutical Isolator** see page 56

Challenge

- Safety light curtains that scan across the isolator internally must be easily cleaned and hold-up to the sterilization process
- Safeguarding large filling and packaging systems have multiple safeguarding points and zones

Key Features

- IP67/IP69K, hygienically designed and chemically-resistant tubular enclosed EZ-SCREEN LS
- Scalable safety solution

Featured Solution

EZ-SCREEN LS
(IP69K)

Other Solutions

EZ-SCREEN LP



Key Benefits

- Designed to work in the harsh environment of a sterile filling and packaging systems

Safety Monitoring see page 60

Challenge

- Safeguard machine with variable safety add-ons depending on customer needs
- Complex logic or multiple safety scenarios
- Communicate with HMI to display machine status

Key Features

- Free, easy-to-use software using drag and drop function blocks
- Simulation mode
- Expandable I/O modules
- Ethernet and Profinet communications

Featured Solution

XS26-2

Other Solutions

SC26-2



Key Benefits

- Configure safety program in minutes
- Control and monitor all the safety devices on the filling equipment
- Test configuration without need to wire or even own safety controller
- Base controller with 26 inputs and two dual-channel safety outputs can be expanded to fit machine requirements
- Ethernet-enabled models allow for easy communications with PLC or HMI





Solutions for Remote Monitoring

Real-time monitoring of machine status allows supervisors to address any issues as they arise, minimizing machine downtime and potentially resolving small issues before they become big problems. Providing clear indication of status at a machine is a necessary requirement. Communicating that status information from a machine to other devices makes it possible for personnel to monitor multiple machines on a factory floor from a convenient location.

Solutions for Remote Monitoring

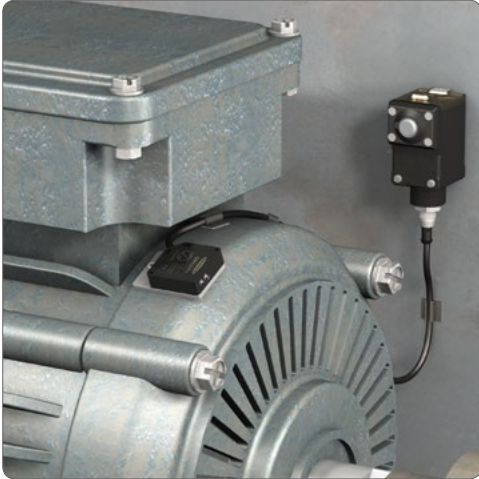

see page 54

Temperature and Vibration Monitoring

Challenge

- Off-line motor testing requires costly down time and can miss changes between testing
- On-line or dynamic testing may neglect key symptoms that indicate motor decline

Key Features

- Sensor continuously monitors RMS velocity and temperature to detect problems early
- Monitor remotely using wireless I/O instead of running cable
- Schedule maintenance without disrupting production by getting email or text in real time when vibration threshold has been exceeded

Featured Solution

QMV42VT1 or QMV42T2 (with DX80 nodes, Q45U Nodes, or MultiHop Modbus RTU radios)



Key Benefits

- Automate the testing process to save time and better predict mechanical failure
- Save maintenance costs by scheduling motor rework rather than unplanned downtime

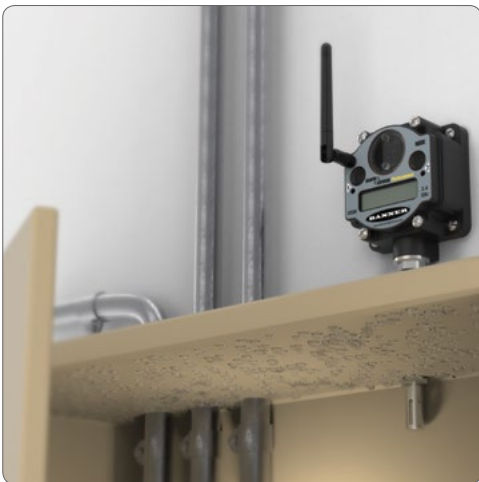

see page 55

Temperature and Humidity Monitoring

Challenge

- Running power and signal wire to sensors may require long conduit runs overhead or underground
- Conduit runs over production lines lead to costly downtime
- Checking temperature and humidity manually is time consuming and the human factor can lead to errors

Key Features

- Battery-powered nodes with compatible temperature and humidity sensors are perfect for ease of installation
- Temperature accuracy of +/- 0.3 °C and humidity accuracy of +/- 2% relative humidity
- Signal is transmitted wirelessly over radio frequencies
- Up to 47 nodes can be added per gateway creating an efficient network collecting data from multiple points

Featured Solution

M12FTH (with DX80 Node, Q45U Node, or MultiHop Modbus RTU radios)



Key Benefits

- Effective solution that reduces the scrap product from out of specification temperatures or humidity
- Easily monitor environmental conditions in locations previously too difficult or expensive to access



see page 51

Barrel, Tote, or Tank Level Inspection

Challenge

- Difficult to tell how much liquid product is in a barrel, tote or tank
- Running out of product at the wrong time can be a hassle and create unnecessary production loss
- Running cables for power and signal wires to barrels, totes or tanks for automatic level monitoring can be expensive and creates a potential tangled mess as items are moved around

Key Features

- Ultrasonic sensor specifically for tank level monitoring, is optimized for power consumption and has threaded housing to fit a bung of a barrel or tote
- Utilizes power from batteries inside the node for ease of installation and use
- Signal can be monitored remotely with no cables by using wireless radio waves

Featured Solution

K50U Ultrasonic (with DX80 Node, Q45U Node, or MultiHop Modbus RTU radios)



Key Benefits

- Easily monitor remote and mobile barrels, totes and tanks
- Empty barrels are switched with full ones in a timely manner with no production loss
- Manage inventory with real time data indicating when to re-order materials

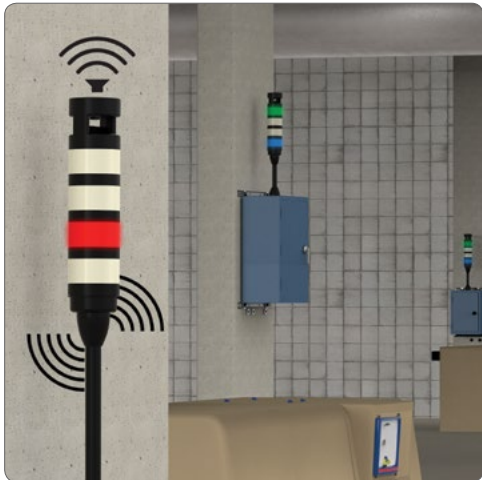

see page 74

Machine Indicator Tower Lights with Wireless Connectivity

Challenge

- Placing indicators in locations that don't have an existing signal cable
- Long conduit runs are costly and installation may cause unnecessary down time
- Legacy machines often don't have the ability to send data to the network

Key Features

- Flexible solution for placing an indicator in the desired location
- Line of sight range of signal is up to 2 miles
- Bright LED's for easy visual monitoring of a machine's condition
- Wireless connectivity enables machine status to be collected on legacy machines

Featured Solution

TL70 Wireless Tower Light



Key Benefits

- Wireless connectivity results in more uptime and efficient troubleshooting
- Easy installation compared to hard wiring tower lights into the network



see page 53

Line Throughput/Scoreboarding/Part Counting

Challenge

- Monitoring machine production throughput requires time-consuming electrical installation
- Each machine and production line may have unique product detection needs

Key Features

- Nodes on a machine monitor the signal on existing sensors and wirelessly transmit the signal back to a Gateway
- Log the data and communicate to the network or the cloud
- Show production metrics on scoreboard

Featured Solution

Q4X DXM100



Key Benefits

- Easy and cost effective installation
- Add counting capabilities to legacy machines



see page 78

Wireless Clean Room Indication

Challenge

- Monitor the status of each clean room in one central location without adding long conduit runs
- Signal personnel when it is safe to enter and exit the clean room.

Key Features

- Up to 47 wireless nodes can wirelessly send a wide variety of data to a central gateway.
- Logic controller with action rules and ScriptBasic programming

Featured Solution

K70L Wireless DXM100



Key Benefits

- Without adding additional wiring, send current temperature, humidity, pressure and entry/exit door status from every clean room to a central monitoring room
- Wirelessly activate an indication light and lock or unlock the entry/exit doors based on the room parameters



Products

Sensors

LE.....	40
LTF.....	41
R58E.....	42
Q4X.....	43
QS18.....	44
QS30.....	46
T18-2.....	47
DF-G3.....	48

Wireless

K50U.....	51
QT50U.....	52
DXM.....	53
QM42.....	54
M12F.....	55

Safety

EZ-SCREEN LS.....	56
E-Stop Button.....	58
XS26-2.....	60

Vision

VE Camera.....	61
iVu TG.....	64
iVu BCR.....	64

Lighting & Indicators

WLS15.....	65
WLS27.....	66
WLB32.....	68
WLB92.....	70
TL50.....	72
TL70.....	74
K50L2.....	76
S22 Touch.....	77
K70L.....	78



LE Series

Laser Sensor

- The LE laser sensors are ready to measure right out of the box with easy adjustment, setup and use.
- Easy adjustment with a two-line, eight-character intuitive display
- Repeatability and accuracy for challenging targets, from metal to black rubber
- Visible 2 laser for small spot size and simple alignment
- Applications see page 10, 16, 24

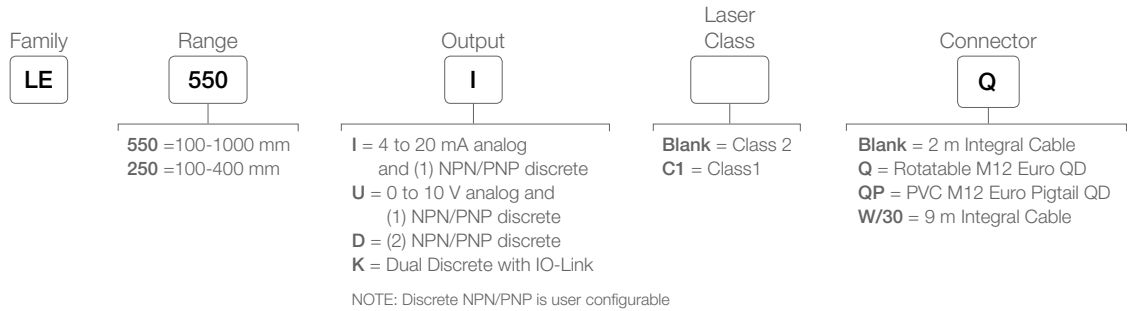

5-pin M12 Euro-Style with Shield

MQDEC2-515
MQDEC2-515RA
5 m (15')

Additional lengths available on bannerengineering.com

Specifications

Supply Voltage and Current	12 to 30 V dc Normal Run Mode: 1.7 W, Current consumption less than 70 mA at 24 V dc
Sensing Beam	Visible red Class 2 laser, 650 nm
Construction	Housing: die-cast zinc Lens: polycarbonate
Environmental Rating	IP67, NEMA 6
Operating Conditions	Temperature: -20 to +55 °C Humidity: 90% at +55 °C
Certifications	





LTF Series

High-Performance Laser Time-of-Flight

- Best in class combination of range, repeatability and accuracy enable highly reliable target detection and precise distance measurement
- Two-line, eight-character display and push-button programming for easy setup, troubleshooting and real-time distance measuring
- Durable IP67 housing, high ambient light immunity and stable performance across temperatures provide reliable performance in challenging environments
- Advanced options, including delay timers, advanced triggered measurement modes and cross-talk avoidance
- Applications see page 10, 24

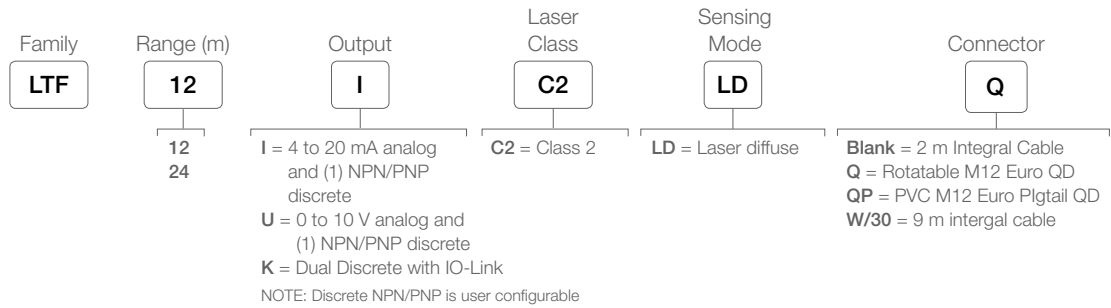

SMBLTFL



SMBLTFU



SMBAMSSLTFP



SMBLTFFA
includes 3/8" bolt for mounting
SMBLTFAM10
includes 10 mm bolt for mounting
SMBLTFAM12
clamps directly onto industry standard bracket systems of 1/2" or 12 mm rods



5-pin M12 Euro-Style with Shield

4-pin M12 Euro-Style Double-ended
Use for: IO-Link Models

Additional lengths available on bannerengineering.com

MQDEC2-515
MQDEC2-515RA
5 m (15')

MQDEC2-412
MQDEC2-412RA
4 m (12')

Specifications

Supply Voltage and Current	12 to 30 V dc	
Sensing Beam	Visible red laser; class 2	
Range	50 to 24000 mm (1.97 to 472.44 in)	
Response Time	Fast: 1.5 ms Standard: 8 ms Medium: 32 ms Slow: 256 ms	
Beam Spot Size	Distance (mm)	Size
	50	6.5 mm
	7500	10 mm
	12000	12.5 mm
	24000	35 mm
Repeatability (1)	±0.15 to 2 mm (Slow 256 ms shown. For more info see datasheet.)	
Resolution	< 0.3 to 3 mm (Resolution measured as twice repeatability with white target at slow response speed at 20 °C)	
Construction	Die-cast zinc housing; acrylic window	
Environmental Rating	IEC IP67; NEMA 6	
Operating Conditions	Temperature: -20 to +55 °C Humidity: 90% at +55 °C maximum relative humidity (non-condensing)	
Certifications		

R58E Series

Registration Mark Sensor



- The R58E sensors offer maintenance-free, solid-state reliability for color contrast applications. With a fast, 50-microsecond sensing response time, the R58E provides excellent registration repeatability, even in speedy applications.
- Bipolar outputs
- 10,000 actuations per second and 15 microsecond repeatability
- Rugged mechanical housing rated to IP67
- Applications see page 18

➡ Visible Red, Green or Blue LED, depending on registration mark

Sensing Mode/LED	Focus	Connection	Output Type	Models	
				Parallel	Perpendicular
<p>CONVERGENT</p>	10 mm	2 m	Bipolar NPN/PNP	R58ECRGB1	R58ECRGB2
		5-pin Euro Pigtail QD	Bipolar NPN/PNP	R58ECRGB1Q	R58ECRGB2Q
		2 m	PNP	R58BPCRGB1	R58BPCRGB2
		5-pin Euro Pigtail QD	PNP	R58BPCRGB1Q	R58BPCRGB2Q
		2 m	NPN	R58BNCRGB1	R58BNCRGB2
		5-pin Euro Pigtail QD	NPN	R58BNCRGB1Q	R58BNCRGB2Q



5-pin Euro-Style
Used with: *Expert* models

MQDEC2-515
MQDEC2-515RA
5 m (15')

4-Pin Euro-Style
Used with: R58 models

MQDC-415
MQDC-415RA
5 m (15')

Additional lengths available on bannerengineering.com

Specifications

Supply Voltage and Current	10 to 30 V dc (10% max. ripple) R58A: 36 mA exclusive of load R58B & R58E: 75 mA @ 10 V dc 35 mA @ 30 V dcw
Output Configuration	R58 Expert & R58A: Bipolar: One current sourcing (PNP) and one current sinking (NPN) R58B: Single output: One current sourcing (PNP) or one current sinking (NPN)
Output Response Time	50 microseconds
Repeatability	15 microseconds
Construction	Zinc alloy die-cast housing with black painted finish and o-ring sealed lens port cap Lens: Acrylic Lens port cap and lens holder: ABS Sensitivity and LO/DO adjusters: Acetal QD: Anodized aluminum
Environmental Rating	IEC IP67
Operating Conditions	Temperature: R58E: -10 to +50 °C R58A & R58B: -10 to +55 °C Relative humidity: 90% at 50 °C (non-condensing) Storage temperature: -20 to +80 °C

Certification





Q4X Series

Laser Measurement Sensor

- Save time and money with the Q4X which is ready to measure right out of the box
- A simple user experience from installation to setup
 - Bright spot alignment
 - Three push buttons simplify setup
 - Intuitive menus
- Four-digit display shows distance to target in mm
- FDA-grade stainless steel is suitable for IP69K washdown environments
- Applications see page 10, 16, 24, 30, 32

Threaded

Family	Housing Style	Output	Mode	Range	Connector
Q4X	T	B	LAF	300	Q8
	T = 18 mm Threaded Barrel	B = Bipolar Discrete NPN & PNP† K = Dual Discrete with IO-Link	U = 0 to 10 V Analog I = 4 to 20 mA Analog LAF = Laser Adjustable-Field COD = Clear Object	600 = 25-600 mm* 500 = 25-500 mm** 300 = 25-300 mm†† 100 = 25-100 mm	Q8 = Integral QD†

Flush

Family	Housing Style	Output	Mode	Range	Connector
Q4X	F	N	LAF	310	Q8
	F = Flush face	P = PNP N = NPN K = Dual Discrete with IO-Link	U = 0 to 10 V Analog I = 4 to 20 mA Analog LAF = Laser Adjustable-Field	610 = 35-610 mm* 310 = 35-310 mm 110 = 35-110 mm	Q8 = Integral QD†

* Only available in Dual Discrete with IO-Link models
** Not available in Dual Discrete with IO-Link models
† Clear Object models only available with bipolar output
†† Clear object only this range

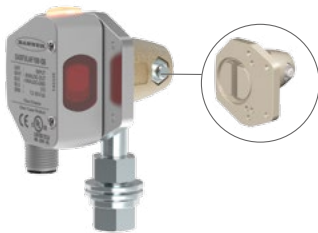

SMBQ4XFAM12
clamps directly onto industry standard bracket systems of 1/2" or 12 mm rods

SMBQ4XFAM10
includes 3/8" bolt for mounting



SMB18A



SMBAMS18P



5-pin Euro-Style
Used with: Analog models

MQDEC2-515
MQDEC2-515RA
5 m (15')



5-Pin Washdown Euro-Style
Used for: Analog Washdown

MQDCWD-506
2 m (6.5')



4-pin Euro-Style
Used with: NPN, PNP, Dual Discrete

MQDC-415
MQDC-415RA
5 m (15')



5-pin Euro-Style
Used with: Bipolar

MQDC1-515
MQDC1-515RA
5 m (15')



4-Pin Washdown Euro-Style
Used for: NPN, PNP, Dual Discrete

MQDC-WDSS-0415
5 m (15')



5-Pin Washdown Euro-Style
Used for: Bipolar

MQDC-WDSS-0515
5 m (15')

Additional lengths available on bannerengineering.com

Specifications

Supply Voltage and Current	10 to 30 V dc at less than 675 mW 12 to 30 V dc for Analog models
Sensing Beam	Visible red Class 1 laser, 655 nm
Output Response Time	User selectable: 50 ms, 25 ms, 10 ms, 3 ms and 1.5 ms
Construction	Housing 316 L stainless steel; PMMA acrylic lens cover, Polysulfone lightpipe and display window
Environmental Rating	IP67 per IEC60529; IP68 per IEC60529; IP69K per DIN40050-9
Operating Conditions	Temperature: -10 °C to +50 °C Humidity: 35% to 95% relative humidity
Certifications	chemical compatibility on some models; contact Banner Engineering for details



QS18 Laser

DC-Operated Long-Range Laser Sensors

- Narrow visible beam spot for easy alignment and small object detection
- Long sensing ranges
- Available in opposed, diffuse and retroreflective mode
- Applications see page 16

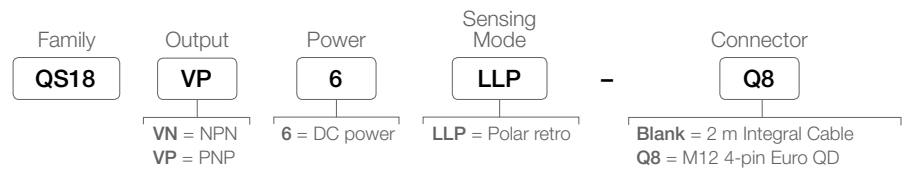

Specifications

Supply Voltage and Current	10 to 30 V dc (10% max. ripple) at less than 35 mA
Output Response Time*	700 microseconds ON/OFF
Repeatability*	130 microseconds
Construction	Housing: ABS Lens Cover: acrylic Window: PMMA
Environmental Rating	Rated IEC IP67; NEMA 6; UL Type 1
Operating Conditions	Temperature: -10° to +50 °C Relative humidity: 90% @ 50 °C (non-condensing)
Certifications	CE



QS18 Expert™

Clear Object Detection Sensor

- Response speed of 400 µs ON/OFF
- Coaxial optics and small spot size for applications with space limitations
- ClearTracking algorithm provides reliable operation by compensating for dust build-up and ambient temperature changes
- Applications see page 11, 17, 25

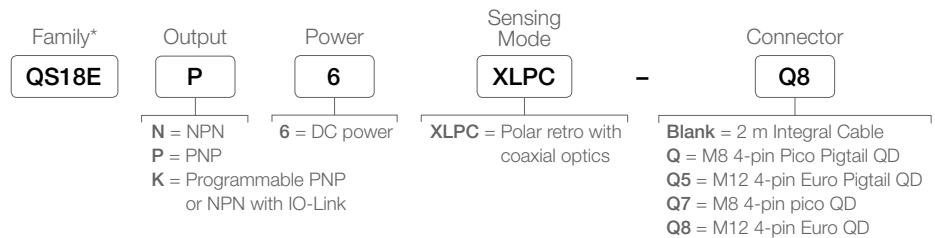

* All models require a reflector



SMBQ4XFA



SMBQS18A



SMB18A



SMBQS18AF



SMB18SF



4-pin M12 Euro-Style

4-pin M8 Pico-Style

MQDC-415
MQDC-415RA
5 m (15')

PKG4M-5
PKW4M-5
5 m (15')

Additional lengths available on bannerengineering.com

Specifications

Supply Voltage	10 to 30 V dc (10% max. ripple) at less than 35 mA, exclusive of load; 10 to 24 V dc @ greater than 55° C	
Output Response Time	400 microseconds ON/OFF	
Repeatability	100 microseconds	
Range	Depends on reflector	
Construction	Housing: ABS Window: PMMA	
Environmental Rating	Meets NEMA 6; IEC IP67; UL Type 1	
Operating Conditions	Temperature: -20° to +70° C	Relative humidity: 90% @ 50° C (non-condensing)

Certifications





QS30 Water Detection

DC-Operated Long-Range Sensors

- Ability to work reliably in low contrast applications
- Ability to detect liquid in translucent and opaque bottles
- 1450 nm infrared wavelength to enhance contrast of clear liquids
- Applications see page 17, 25

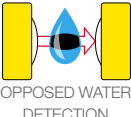
Sensing Mode	Range	Connection	Output Type	Model	 Infrared LED
 OPPOSED WATER DETECTION	4 m	2 m	—	QS30EXH2O Emitter*	
		5-pin Euro Pigtail QD	—	QS30EXH2OQ5 Emitter*	
		2 m	Bipolar NPN/PNP LO	QS30ARXH2O	
		5-pin Euro Pigtail QD	Bipolar NPN/PNP LO	QS30ARXH2OQ5	
		2 m	Bipolar NPN/PNP DO	QS30RRXH2O	
		5-pin Euro Pigtail QD	Bipolar NPN/PNP DO	QS30RRXH2OQ5	
 OPPOSED WATER DETECTION	2 m	2 m	Bipolar NPN/PNP LO	QS30ARH2O	
		5-pin Euro Pigtail QD	Bipolar NPN/PNP LO	QS30ARH2OQ5	
		2 m	Bipolar NPN/PNP DO	QS30RRH2O	
 SUPER HIGH-POWER OPPOSED WATER DETECTION	8 m	5-pin Euro Pigtail QD	Bipolar NPN/PNP DO	QS30RRH2OQ5	
		2 m	—	QS30EXSH2O Emitter*	
		5-pin Euro Pigtail QD	—	QS30EXSH2OQ5 Emitter*	
		2 m	Bipolar NPN/PNP LO	QS30ARXSH2O	
 OPPOSED WATER DETECTION	8 m	5-pin Euro Pigtail QD	Bipolar NPN/PNP LO	QS30ARXSH2OQ5	
		2 m	Bipolar NPN/PNP DO	QS30RRXSH2O	
 OPPOSED WATER DETECTION	8 m	5-pin Euro Pigtail QD	Bipolar NPN/PNP DO	QS30RRXSH2OQ5	
		2 m	Bipolar NPN/PNP DO	QS30RRXSH2OQ5	



SMBQS30L



SMBQS30Y



SMBQS30YL



SMB30A



5-pin Euro QD (for Q models)

MQDC1-515
5 m (15')
MQDC1-515RA
5 m (15')

Additional lengths available on bannerengineering.com

Specifications

Supply Voltage and Current	Emitters (Water): 10 to 30 V dc (10% max. ripple) at less than 80 mA Receivers (Water): 10 to 30 V dc (10% max. ripple) at less than 65 mA Analog Receivers (water): 15 to 30 V dc (10% max. ripple) at less than 65 mA (exclusive of load)	
Output Configuration	Bipolar: One PNP (current sourcing) and one NPN (current sinking); Light Operate (LO) or Dark Operate (DO) selectable or configurable (depending on model)	
Output Response Time	Opposed (Water): 10 x excess gain or more— Standard: 1 millisecond ON/OFF 2x to 10x excess gain— Standard: 3 milliseconds ON/OFF	Super High-Power: 10 milliseconds ON/OFF Super High-Power: 30 milliseconds ON/OFF
Repeatability	Opposed (Water): 10 x excess gain or more— Standard: 500 microseconds 2x to 10x excess gain— Standard: 2.5 milliseconds	Super High-Power: 5 milliseconds Super High-Power: 25 milliseconds
Construction	Housing: ABS plastic Lens cover: acrylic	
Environmental Rating	Opposed (Water): IEC IP67 (nema 6); PW12 1200 PSI washdown per NEMA PW12	
Operating Conditions	Opposed (Water), Opposed (High-Power): -20° to +60° C	Relative humidity: 90% (non-condensing)g

Certifications





T18-2 Series

Epoxy Encapsulated Right-Angle Sensor

- Chemically robust epoxy encapsulated plastic sensors for wash-down applications
- Permanent laser etched product marking will not wear off after repeated cleaning cycles
- Food grade plastics materials used for all exposed surfaces
- Powerful and bright visible red emitter beam for easy alignment and set-up
- Highly visible output and dual-function power and stability indicators
- Advanced ASIC technology makes sensor resistant to optical and electrical noise source
- Applications see page 12, 19

Sensing Mode	Range	Output Type	Model*	⇒ Infrared LED
 OPPOSED	25 m	—	T18-2NAEL-2M Emitter	
	25 m with beam inhibit		T18-2NAEJ-2M Emitter	
	25 m with adjustment		T18-2NAES-2M Emitter	
 OPPOSED	25 m	Complementary NPN	T18-2VNRL-2M Receiver	
	25 m with adjustment	Complementary PNP	T18-2VPRL-2M Receiver	
		Complementary NPN	T18-2VNRS-2M Receiver	
		Complementary PNP	T18-2VPRS-2M Receiver	
 POLARIZED RETRO	6 m with BRT-84 reflector	Complementary NPN	T18-2VNLP-2M	
	6 m with BRT-84 reflector, with adjustment	Complementary PNP	T18-2VPLP-2M	
		Complementary NPN	T18-2VNLPC-2M	
 RETRO	7.5 m with BRT-84 reflector, with adjustment	Complementary NPN	T18-2VNLV-2M	
		Complementary PNP	T18-2VPLV-2M	
 DIFFUSE	750 mm with adjustment	Complementary NPN	T18-2VNDL-2M	
	300 mm with adjustment	Complementary PNP	T18-2VPDL-2M	
		Complementary NPN	T18-2VNDL-2M	
		Complementary PNP	T18-2VPDL-2M	
Sensing Mode	Range	Output Type	Model with Red Emitter*	Model with Infrared Emitter*
 FIXED-FIELD	30, 50, 75, 100, 150, 200 mm replace ". ." in model number with range required	Complementary NPN	T18-2VNFF.-2M	T18-2VNFF..IR-2M
		Complementary PNP	T18-2VPFF.-2M	T18-2VPFF..IR-2M

* Only 2 m (6.5 ft) PVC cable models are listed. To order 9 m (30 ft) PVC cable models, add suffix "9M" (for example, T18-2VNDL-9M). To order 4-pin Euro M12 integral QD models, add suffix "Q8" (for example, T18-2VNDL-Q8).



SMB18A



SMB18FA..

Stainless steel models available



4-pin Euro-Style
Used with: NPN, PNP, Dual Discrete

4-Pin Washdown Euro-Style
Used for: NPN, PNP, Dual Discrete

MQDC-415
MQDC-415RA
5 m (15')

MQDC-WDSS-0415
5 m (15')

Additional lengths available on bannerengineering.com

Specifications

Supply Voltage and Current	10 to 30 V dc for ambient temperature $\leq 55^\circ\text{C}$	10 to 24 V dc for ambient temperature $> 55^\circ\text{C}$
Output Configuration	Complementary PNP or NPN by model number	
Output Response Time	Response is independent of signal strength Opposed models: 1.5 milliseconds ON, 1 millisecond OFF Retro, Polarized Retro, and Diffuse models: 1.5 milliseconds ON, 0.75 milliseconds OFF	Fixed Field models: 2 milliseconds ON, 2 milliseconds OFF Delay on Power-up: 100 milliseconds; outputs do not conduct during this time
Repeatability	Repeatability is independent of signal strength Opposed models: 170 microseconds	Retro, Polarized Retro, and Diffuse models: 100 microseconds Fixed Field models: 200 microseconds
Construction	Housing, M12 QD, and cover: Black or Yellow PBT polyester Indicator windows: Clear PBT polyester	Indicator cover and gain pot driver: PBT polyester Front window: PMMA
Environmental Rating	IEC IP69K	
Operating Conditions	-40°C to $+70^\circ\text{C}$ (-40°F to $+158^\circ\text{F}$) 95% at $+50^\circ\text{C}$ maximum relative humidity (non-condensing)	
Certifications		



DF-G3 Series

Long-range Fiber Optic Amplifiers

- World-class long-range sensing capability, more than 3 m (10 ft) with opposed mode fibers
- Easy to read dual digital displays show both signal level and threshold simultaneously
- Cross-talk avoidance function allows seven inspections in dense sensing point applications
- Models with IO-Link enable a point-to-point communication link between a master device and a sensor, facilitating remote monitoring, teaching, and configuration
- Operator control of the sensitivity (hysteresis) provides additional detection sensitivity, or a stabilized output depending on the application details
- Applications see page 25, 32

IO-Link

➔ Visible Red LED ➔ Infrared LED

Sensing Beam Color	Range	Connection	Output	Models
Visible Red, 635 nm	3,000 mm	2 m	Channel1: IO-Link, push/pull Channel2: PNP only output, or input	DF-G3-KD-2M
Infrared, 850 nm	6,000 mm	2 m	Channel1: IO-Link, push/pull Channel2: PNP only output, or input	DF-G3IR-KD-2M

Single Output

➔ Visible Red LED ➔ Infrared LED

Sensing Beam Color	Range	Connection	Models	
			NPN Models	PNP Models
Visible Red	3,000 mm	2 m	DF-G3-NS-2M	DF-G3-PS-2M
Infrared, 850 nm	6,000 mm	2 m	DF-G3IR-NS-2M	DF-G3IR-PS-2M

Dual Output

➔ Visible Red LED ➔ Infrared LED

Sensing Beam Color	Range	Connection	Models	
			NPN Models	PNP Models
Visible Red	3,000 mm	2 m	DF-G3-ND-2M	DF-G3-PD-2M
Infrared, 850 nm	6,000 mm	2 m	DF-G3IR-ND-2M	DF-G3IR-PD-2M

Analog

➔ Visible Red LED ➔ Infrared LED

Sensing Beam Color	Range	Connection	Analog Output	Models	
				NPN Models	PNP Models
Visible Red	3,000 mm	2 m	Voltage: 0-10 V DC	DF-G3-NU-2M	DF-G3-PU-2M
			Current: 4-20 mA	DF-G3-NI-2M	DF-G3-PI-2M
Infrared, 850 nm	6,000 mm	2 m	Voltage: 0-10 V DC	DF-G3IR-NU-2M	DF-G3IR-PU-2M
			Current: 4-20 mA	DF-G3IR-NI-2M	DF-G3IR-PI-2M

* Only 2 m (6.5 ft) PVC cable models are listed. To order M8 Pico pigtail, change suffix "2M" to "Q3" (for example, DF-G3-NU-Q3). To order M12 Euro pigtail, change suffix "2M" to "Q5" (for example, DF-G3-NU-Q5).



DF-G3 Series

Water Detection Fiber Optic Amplifiers

- 1450 nm infrared wavelength to enhance contrast of clear liquids
- Reliable detection of presence or absence of water-based liquids
- Easy to read dual digital displays show both signal level and threshold simultaneously
- Cross-talk avoidance function allows seven inspections in dense sensing point applications
- Models with IO-Link enable a point-to-point communication link between a master device and a sensor, facilitating remote monitoring, teaching, and configuration
- Applications see page 30

Single Output

Sensing Beam Color	Range	Connection	Infrared LED	
			NPN Models	PNP Models
Long Infrared, 1450 nm	900 mm	2 m	DF-G3LIR-NS-2M	DF-G3LIR-PS-2M

Dual Output

Sensing Beam Color	Range	Connection	Infrared LED	
			NPN Models	PNP Models
Long Infrared, 1450 nm	900 mm	2 m	DF-G3LIR-ND-2M	DF-G3LIR-PD-2M

Analog

Sensing Beam Color	Range	Connection	Analog Output	Infrared LED	
				NPN Models	PNP Models
Long Infrared, 1450 nm	900 mm	2 m	Voltage: 0-10 V DC	DF-G3LIR-NU-2M	DF-G3LIR-PU-2M
			Current: 4-20 mA	DF-G3LIR-NI-2M	DF-G3LIR-PI-2M

* Only 2 m (6.5 ft) PVC cable models are listed. To order M8 Pico pigtail, change suffix "2M" to "Q3" (for example, DF-G3-LIR-Q3). To order M12 Euro pigtail, change suffix "2M" to "Q5" (for example, DF-G3-LIR-Q5).



Additional DF-G1, DF-G2, and DF-G3 models are available at bannerengineering.com



DIN-35..



SA-DIN-BRACKET



SA-DIN-CLAMP
Mounting Clamp



4-pin Euro QD

MQDC-415
5 m (15')
MQDC-415RA
5 m (15')



4-pin Pico QD
Straight snap-on connector

Right-angle snap-on connector

PKG4-2
2 m (6')

PKW4Z-2
2 m (6')

Additional lengths available on bannerengineering.com

Specifications

Supply Voltage and Current	NPN/PNP Models: 10 to 30 V dc (10% max ripple) Voltage output models: 12 to 30 V dc (10% max ripple) Standard Mode: 960 mW, Current consumption < 40 mA @ 24 V dc	IO-Link Models: 18 to 30 V dc (10% max ripple) Current output models: 10 to 30 V dc (10% max ripple) ECO Display Mode: 720 mW, Current consumption < 30 mA @ 24 V dc	
Sensing Beam	DF-G3: Visible red, 635 nm	DF-G3IR: Infrared, 850 nm	DF-G3LIR: Long Infrared, 1450 nm
Supply Protection Circuitry	Protected against reverse polarity, over voltage, and transient voltages		
Output Configuration	NPN/PNP Models: 1 current sourcing (PNP) or 1 current sinking (NPN) output, depending on model IO-Link Models: 1 push-pull and 1 PNP (complementary outputs) Voltage output models: 1 analog voltage output (user configurable as 1 V to 5 V or 0 V to 10 V) with 1 current sinking (NPN) or 1 current sourcing (PNP) discrete output Current output models: 1 analog current output (4 mA to 20 mA) with 1 current sinking (NPN) or 1 current sourcing (PNP) discrete output		
Output Rating	100 mA max. load (derate 1 mA per °C above 30 °C) OFF-state leakage current: NPN/PNP/current: < 5 µA at 30 V dc IO-Link: < 50 µA at 30 V dc	ON-state saturation voltage: NPN: < 1.5 V PNP: < 2 V IO-Link: < 2 V	
Output Protection Circuitry	Protected against output short-circuit, continuous overload, transient over-voltages, and false pulse on power up		
Output Response Time	High Speed: 500 us Standard: 2 ms Extra Long Range: 24 ms	Fast: 1000 us Long Range: 8 ms	
Delay at Power-up	500 milliseconds max.; outputs do not conduct during this time		
Indicators	Red 4-digit Display: Signal Level Green 4-digit Display: Threshold Yellow LED: Output conducting (In Program Mode, Red and Green displays are used for programming menus)		
Construction	Black ABS/polycarbonate alloy (UL94 V-0 rated) housing, clear polycarbonate cover		
Environmental Rating	IEC IP50, NEMA 1		
Operating Conditions	Temperature: -10 to +55 °C	Storage: -20 to +85 °C	Relative Humidity: 50% @ +50 °C (non-condensing)
Certifications	  		



K50U Series

Ultrasonic Sensor for Wireless Level and Tank Monitoring

- Three meter sensing range with a 300 mm dead zone
- Provides a distance measurement from the target to the sensor
- Built-in temperature compensation
- Rugged design for demanding sensing environments; rated IEC IP67, NEMA 6P
- Functions as a Modbus slave device using RS-485
- Applications see page 36

Range and Frequency	Supply Voltage	I/O	Models
Range: 300 mm to 3 m Frequency: 114 kHz	3.6 to 5.5 V dc	Distance to target using a 1-wire serial interface	K50UX1RA
Range: 300 mm to 3 m Frequency: 114 kHz	3.6 to 5.5 V dc or 10 to 30 V dc	Distance to target using Modbus RS-485	K50UX2RA



BWA-BK-006
Mounts both the K50U Ultrasonic sensor and a Wireless Q45 Node



5-pin Double Ended
M12/Euro-Style
with Shield

DEE2R-53D
1 m (3')

Additional lengths available on bannerengineering.com

Specifications

Supply Voltage and Current	3.6 to 5.5 V dc or 10 to 30 V dc
Current	Active comms: 11.3 mA at 30 V dc
Indicators	Two LEDs
Construction	Housing: PBT polyester Transducer: Epoxy/ceramic composite
Sensing Range	Sensing range: 300 mm to 3 m (11.8 in to 118 in)
Resolution	Resolution: 0.1% of distance (1.5 mm minimum)
Sensor Connection	1 ¼ in NPT Connection
Cable Connection	Integral 5-pin M12/Euro-style male quick disconnect (QD)
Environmental Rating	Leakproof design, rated IEC IP67 (NEMA 6)

Certifications





QT50U Series

Long-Range Ultrasonic Sensors

- Features a small ultrasonic dead zone of 200 mm
- Available in a chemically resistant model with a Teflon® flange
- Detects targets at long ranges within confined areas, such as a storage tank, without interference from the tank walls
- Push-button and remote TEACH-mode programming with an external switch, computer or controller for added security and convenience
- Applications see page 10

10-30 V DC

Range	Connection	Output	Models*
200 mm to 8 m	2 m	Selectable 0 to 10 V dc or 4 to 20 mA	QT50ULB QT50ULBQ QT50ULBQ6
	5-pin Mini QD		
	5-pin Euro QD		
200 mm to 8 m	2 m	Selectable Dual NPN or PNP	QT50UDB QT50UDBQ QT50UDBQ6
	5-pin Mini QD		
	5-pin Euro QD		

Universal Voltage, 85-264 V AC/48-250 V DC

Range	Connection	Output Operation Mode	Output	Models*
200 mm to 8 m	2 m	Window-limit (complementary outputs)	SPDT e/m relay	QT50UVR3W QT50UVR3WQ1 QT50UVR3WQ
	5-pin Micro QD			
	5-pin Mini QD			
200 mm to 8 m	2 m	Pump/level control (pump-in and pump-out logic)	SPDT e/m relay	QT50UVR3F QT50UVR3FQ1 QT50UVR3FQ
	5-pin Micro QD			
	5-pin Mini QD			



Add suffix **-CRFV**
to model number
for Teflon®-protected
face and transducer



SMB30A



SMB30MM



SMB30SC



5-pin Euro-Style



5-Pin Micro-Style



5-Pin Mini-Style

MQDEC2-515
MQDEC2-515RA
5 m (15')

MQVR3S-515
MQVR3S-515RA
5 m (15')

MBCC2-512
4 m (12')

Additional lengths available on bannerengineering.com

Specifications

Supply Voltage and Current	Analog models: 10 to 30 V dc (10% max. ripple); 100 mA max @ 10 V, 40 mA max. @ 30 V (exclusive of load) Dual-discrete models: 10 to 30 V dc (10% max. ripple); 100 mA max. @ 10 V, 40 mA @ 30 V (exclusive of load)	
Output Configuration	Analog models: Voltage sourcing: 0 to 10 V dc Current sourcing: 4 to 20 mA Dual-discrete models: Dual PNP or NPN, selectable using DIP switch	
Linearity (Analog Models)	+/- 0.2% of span from 200 to 8000 mm; +/- 0.1% of span from 500 to 8000 mm (1 mm minimum)	
Resolution/Repeatability	1.0 mm	
Output Response Time	Analog models: 100 to 2300 milliseconds Dual-discrete models: 100 to 1600 milliseconds	
Construction	Transducer: Ceramic/Epoxy composite Membrane Switch: Polyester	Housing: ABS/Polycarbonate Lightpipes: Acrylic
Environmental Rating	IEC IP67; NEMA 6P	
Operating Conditions	Temperature: -20 to +70 °C	Relative humidity: 100%
Certifications		

DXM Wireless Controller

Industrial Wireless Controller



- ISM radios available in 900 MHz and 2.4 GHz for local wireless network
- Converts Modbus RTU to Modbus TCP/IP or Ethernet I/P
- Logic controller can be programmed using action rules and text language methods
- Cellular connectivity
- Micro SD card for data logging
- Email and text alerts
- Local I/O options: universal inputs, NMOS outputs, and analog outputs
- Powered by 12 to 30 V dc, 12 V dc solar panel, or battery backup
- RS-232, RS-485, and Ethernet communications ports; and a USB configuration port
- LCD display for I/O information and user programmable LED's
- Applications see page 37

Description	Frequency	Models*
DXM100 Controller, with DX80 Gateway, preconfigured as a protocol converter	900 MHz	DXM100-B1R1
DXM100 Controller, with DX80 Gateway, preconfigured as a protocol converter	2.4 GHz	DXM100-B1R3
DXM100 Controller with MultiHop Data Radio	900 MHz	DXM100-B1R2
DXM100 Controller with MultiHop Data Radio	2.4 GHz	DXM100-B1R4
DXM100 Controller with DX80 Gateway and CDMA cellular module, preconfigured as a protocol converter	900 MHz	DXM100-B1C1R1
DXM100 Controller with DX80 Gateway and CDMA cellular module, preconfigured as a protocol converter	2.4 GHz	DXM100-B1C1R2

* Additional local I/O available with the DXM150 models, contact Banner for more information



PSDINP-24-13
DIN Rail mount
power supply



PSD-24-4
Desktop style
power supply



4-pin Male
Euro-Style

MQDMC-401

Specifications

Supply Voltage	12 to 30 V dc or 12 V dc solar panel and 12 V sealed lead acid battery	
Power Consumption	35 mA average at 12 V	
Solar Power Battery Charging	1 Amp maximum with 20 Watt solar panel	
Radio Range	900 MHz, 1 Watt: Up to 9.6 km (6 miles)	2.4 GHz, 65 mW: Up to 3.2 km (2 miles)
Logging	8 GB maximum; removable Micro SD card format	
Protocols	Modbus RTU Master/Slave, Modbus TCP, and Ethernet/IP	
Construction	Polycarbonate; DIN rail mount option	
Environmental Rating	IP20	
Courtesy Power	One; output at 5 volts , 500 mA maximum	
Switched Power Outputs	5 V/400 mA maximum; 16 V/125 mA maximum	
Analog Outputs	0 to 20 mA or 0 to 10 V dc output Accuracy: 0.1% of full scale +0.01% per °C Resolution: 12 bit	
NMOS Outputs	Less than 1 A max current at 30 V dc ON-state saturation: less than 0.7 V at 20 mA ON condition: Less than 0.7 V Off condition: Open	
Certifications		



QM42 Series

Vibration and Humidity Sensors

- Provides high accuracy vibration (velocity RMS) and temperature measurements
- Manufactured with a robust zinc alloy housing
- Connects via a 1-wire serial interface
- Reduces labor costs by obviating manual checks and eliminating error
- Applications see page 36

I/O	Power	Connection	Models
1-Wire Serial	3.6 to 5.5 V dc	3 m	QM42VT1
RS-485 Modbus	3.6 to 5.5 V dc low power option or 10 to 24 V dc	3 m	QM42VT2



BWA-BK-002



BWA-BK-001



5-pin Double Ended M12/Euro-Style with Shield

DEE2R-53D
1 m (3')

Additional lengths available on bannerengineering.com



RS-485 to USB Adaptor
Used with QM42VT2 to talk to GUI

BWA-HW-006



1-Wire Serial to USB Adaptor
Protocol converter used with QM42VT1 to talk to GUI

BWA-USB1WIRE-001

Specifications

Supply Voltage and Current	3.6 to 5.5 V dc or 10 to 24 V dc	
Vibration	Mounted base resonance: 5.5 kHz nominal Measuring range: 0-46 mm/sec or 0-1.8 in/sec RMS	Frequency Range: 10 – 1000 Hz Accuracy: ± 10% @25 °C
Temperature	Measuring range: -40 to +105 °C (-40 to +221 °F)	Resolution: 0.1 °C Accuracy: ±3 °C
Construction	Housing: Zinc alloy	
Shock	400G	
Environmental Rating	IEC IP67; NEMA 6	
Operating Conditions	Temperature: -40 to +105 °C	

Certifications



M12F Series

Temperature and Humidity Sensors

- Manufactured with a robust metal housing
- Designed to work as a Modbus slave device via RS-485 or with Sure Cross® 1-wire serial interface -P6 nodes, -H6 MultiHop Radios, or Q45 Sensor Node DX80N2Q45TH
- Ships with aluminum grill filter cap; optional stainless steel 10 micrometer sintered filter available separately
- Applications see page 36



Temperature and Humidity

I/O	Power	Connection	Models
RS-485 Modbus	3.6 to 5.5 V dc low power option or 12 to 24 V dc	5-pin Euro QD	M12FTH3Q
1-wire serial interface	3.6 to 5.5 V dc		M12FTH4Q

Temperature

I/O	Power	Connection	Models
RS-485 Modbus	3.6 to 5.5 V dc low power option or 12 to 24 V dc	5-pin Euro QD	M12FT3Q
1-wire serial interface	3.6 to 5.5 V dc		M12FT4Q



5-pin Double Ended
M12/Euro-Style
with Shield

DEE2R-53D
1 m (3')

Additional lengths available on bannerengineering.com



FTH-FIL-001
Aluminum Grill Filter Cap



FTH-FIL-002
Stainless Steel Filter Cap

M12F Specifications

Supply Voltage and Current	3.6 to 5.5 V dc low power option or 12 to 24 V dc
Resolution	Humidity: 0.1% relative humidity Temperature: 0.1 °C
Construction	Housing: metal
Environmental Rating	IEC IP67; NEMA 6
Operating Conditions	Temperature: -40 °C to +85 °C

Certifications



UL US CSA: Class I, Division 2, Groups A, B, C, D — Certificate 1921239



EZ-SCREEN® LS

Rugged Safety Light Screen with Enhanced Features

- Alignment indicators are highly visible and intuitive diagnostics simplify setup, facilitate troubleshooting and streamline installation
- No blind zone design provides end-to-end sensing to eliminate gaps in detection
- Metal end caps, thick aluminum housing and a recessed window to avoid damage from impact
- Standard pairs, cascade systems and extensive accessories to suit a wide variety of safeguarding configurations
- Applications see page 13, 21, 27, 33

Hygienic

Family	System Type	Resolution	Defined Area	Connector
EZLSA-HTE	R	23	770	
	E = Emitter only R = Receiver only	23 = 23 mm	280 = 280 mm 350 = 350 mm 420 = 420 mm 490 = 490 mm 560 = 560 mm 630 = 630 mm	700 = 700 mm 770 = 770 mm 840 = 840 mm 910 = 910 mm 980 = 980 mm 1050 = 1050 mm
				Blank = 25 ft., 8-wire, high durometer PVC Cordset F = Remote Fixed Blanking model with additional 25 ft. cordset for blanking configuration

Standard

Family	System Type	Resolution	Defined Area	Connector*
SLL	P	14	770	P88
	E = Emitter only R = Receiver only P = Pair (Emitter and Receiver)	14 = 14 mm 23 = 23 mm 40 = 40 mm	280 = 280 mm 350 = 350 mm 420 = 420 mm 490 = 490 mm 560 = 560 mm 630 = 630 mm 700 = 700 mm 770 = 770 mm	840 = 840 mm 910 = 910 mm 980 = 980 mm 1050 = 1050 mm 1120 = 1120 mm 1190 = 1190 mm 1260 = 1260 mm 1330 = 1330 mm
			1400 = 1400 mm 1470 = 1470 mm 1540 = 1540 mm 1610 = 1610 mm 1680 = 1680 mm 1750 = 1750 mm 1820 = 1820 mm	P8 = 300 mm pigtail, 8-Pin M12 QD (individual Emitter or Receiver models) P88 = 300 mm pigtail, 8-Pin M12 QD (on BOTH Emitter and Receiver models) Blank = no pigtail, RD connection (for RDLS-8..D cordset)

* 5-pin M12 QD options available (P5 or P55)

Cascadable

Family	Cascadable	System Type	Resolution	Defined Area	Connector*
SLL	C	P	14	770	P88
	C = Cascadable	E = Emitter only R = Receiver only P = Pair (Emitter and Receiver)	14 = 14 mm 23 = 23 mm 40 = 40 mm	280 = 280 mm 350 = 350 mm 420 = 420 mm 490 = 490 mm 560 = 560 mm 630 = 630 mm 700 = 700 mm 770 = 770 mm 840 = 840 mm 910 = 910 mm 980 = 980 mm 1050 = 1050 mm	1120 = 1120 mm 1190 = 1190 mm 1260 = 1260 mm 1330 = 1330 mm 1400 = 1400 mm 1470 = 1470 mm 1540 = 1540 mm 1610 = 1610 mm 1680 = 1680 mm 1750 = 1750 mm 1820 = 1820 mm
					P8 = 300 mm pigtail, 8-Pin M12 QD (individual Emitter or Receiver models) P88 = 300 mm pigtail, 8-Pin M12 QD (on BOTH Emitter and Receiver models) Blank = no pigtail, RD connection (for RDLS-8..D cordset)

* 5-pin M12 QD options available (P5 or P55)

Machine Interface Connections



8-PIN RD
Cordsets

RDLS-815
4.6 m (15')



8-pin Euro-Style
Straight splitter

CSB-M1280M1280
CSB-M1281M1281
CSB-M12815M1281



8-pin M12
Euro-Style

QDE-850D
15.3 m (50')



8-pin Euro-Style
double-ended
male/female

DEE2R-815D
4.5 m (15')
DEE2R-850D
15.3 m (50')

Additional lengths available on bannerengineering.com

Additional lengths available on bannerengineering.com

Cascading Connections



Double-ended
RD to RD

DELS-118E
2.5 m (8.2')
DELS-1115E
4.6 m (15')

Additional lengths available on bannerengineering.com



EZLSA-MBK-11



EZLSA-MBK-12



EZLSA-MBK-16



EZLSA-MBK-20



EZLSA-K30LGR
Connects directly to
SLLCR... cascade receiver



K30LGRXPQ
requires 4-pin QD



K50LGRXPQ
requires 4-pin QD



TL50GRQ
requires 4-pin QD



RD to Euro-Style
Connects indicators
to a cascade receiver

Additional lengths available
on bannerengineering.com

DELSEF-41D
0.3 m (1')
DELSEF-48D
2.5 m (8.2')

Specifications

Supply Voltage at the Device	24 V dc $\pm 15\%$ (use a SELV-rated power supply according to EN IEC 60950). The external voltage supply must be capable of buffering brief mains interruptions of 20 ms, as specified in IEC/EN 60204-1.	
Short Circuit Protection	All inputs and outputs are protected from short circuits to +24 V dc or dc common	
Effective Aperture Angle (EAA)	Meets Type 4 requirements per IEC 61496-2	
Residual Ripple	$\pm 10\%$ maximum	
Electrical Safety Class	III (per IEC 61140: 1997)	
Operating Range	0.1 m to 12 m (4 in to 39 ft) — Range decreases with use of mirrors and/or lens shields: <ul style="list-style-type: none"> • Lens shields — approx 10% less range per shield • Glass-surface mirrors — approx 8% less range per mirror See the specific mirror datasheet for more information	
Resolution	14 mm, 23 mm, or 40 mm, depending on model	
Mounting Hardware	Emitter and receiver each are supplied with a pair of swivel end-mounting brackets (EZLSA-MBK-11). Models 980 mm and longer are supplied with an additional center-mount bracket (EZLSA-MBK-12) for center support in applications with significant vibration. Mounting brackets are 8-gauge cold-rolled steel, black zinc finish.	
Enclosure	Extruded aluminum housing with yellow polyester powder finish standard and well-sealed, rugged die-cast zinc end caps, acrylic lens cover	
Safety Rating	Type 4 per IEC 61496-1, -2 Category 4 PL e per EN ISO13849-1 SIL3 per IEC 61508; SIL CL3 per IEC 62061	
Environmental Rating	Light Screen: IEC IP65/IEC IP67	Enclosure: IP69K
Operating Conditions	-20 to +55 °C (-4 to +131 °F)	95% maximum relative humidity (non-condensing)
Shock and Vibration	Components have passed vibration and shock tests according to IEC 61496-1. This includes vibration (10 cycles) of 10-55 Hz at 0.35 mm (0.014 in) single amplitude (0.70 mm peak-to-peak) and shock of 10 g for 16 milliseconds (6,000 cycles).	

Certifications





E-Stop Button

Illuminated 30 mm Mount

- Illumination allows for easy identification of which E-stop has been activated.
- Easy installation and no assembly or individual wiring required
- Push-to-stop, twist-to-release or pull-to-release operation per IEC 60947-5-5
- Compliant with ANSI B11.19, ANSI NFPA79 and IEC/EN 60204-1 Emergency Stop requirements
- Incorporate with OTB/STB optical touch button for a simplified operator station that does not require an additional enclosure.
- “Safe Break Action” ensures NC contacts will open if the contact block is damaged or separated from the actuator
- Models designed to interface with Safety BUS nodes/gateways
- Applications see page 13, 21, 27, 33

Description	Illumination	Models
2NC / 1NO (PNP)	YEL/RED-Flash/Solid	SSA-EB1PLYR-12ECQ8
2NC / 1NO (PNP)	GREEN/RED-Flash/Solid	SSA-EB1PLGR-12ECQ8
2NC / 1NO (PNP)	OFF/RED-Flash/Solid	SSA-EB1PLXR-12ECQ8
2NC / 1NO (PNP)	OFF/RED-Flash/Solid, with 60 mm button	SSA-EB2PLXR-12ECQ8
2NC / 1NO (PNP)	OFF/RED-Solid/Solid	SSA-EB1PL-12ECQ8
2NC – Safety BUS node compatible	YEL/RED-Flash	SSA-EB1PLYR-02ECQ5A
2NC – Safety BUS node compatible	OFF/RED-Flash	SSA-EB1PLXR-02ECQ5A
2NC – Safety BUS node compatible	OFF/RED-Solid	SSA-EB1PL-02ECQ5A
2NC – Safety BUS node compatible	Illuminated button, OFF (armed), RED (solid, PUSH ON)	SSA-EB1PL2-02ECQ5A
2NC – Safety BUS node compatible	YEL/RED-Flash	SSA-EB1PLYR-02ECQ5B
2NC – Safety BUS node compatible	OFF/RED-Flash	SSA-EB1PLXR-02ECQ5B
2NC – Safety BUS node compatible	OFF/RED-Solid	SSA-EB1PL-02ECQ5B
2NC – Safety BUS node compatible	Illuminated button, OFF (armed) RED (solid, PUSH ON)	SSA-EB1PL2-02ECQ5B

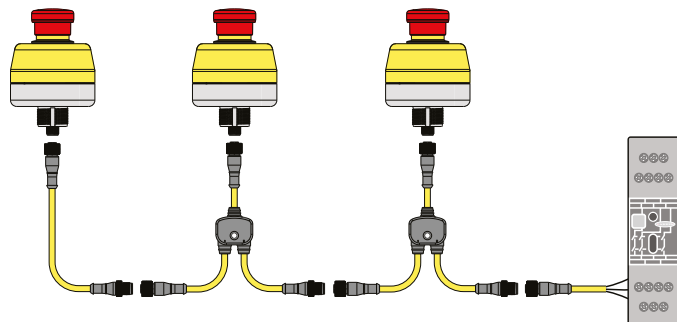

SSA-MBK-EEC1



SSA-MBK-EEC2



SSA-MBK-EEC3



SSA-EB1P-ECWC
Washdown cover



(A)
Euro-Style
Straight
splitter

4-Pin
CSS-M12F43M12M41M12F41
0.9 m (3')
8-Pin
CSS-M12F83M12M81M12F81
0.9 m (3')

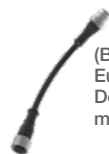

(B)
Euro-Style
Double-ended
male/female

5-Pin
DEE2R-53D
0.9 m (3')
8-Pin
DEE2R-83D
0.9 m (3')





(C)
M12/Euro-Style

4-Pin
MQDC-415
5 m (15')
MQDC-415RA
5 m (15')
8-Pin
MQDC2S-815
5 m (15')
MQDC2S-815RA
5 m (15')

Additional lengths available on bannerengineering.com

30 mm E-Stop Push Button Specifications

Housing / Button Mounting	Polycarbonate / Polyamide Threaded base has M30 x 1.5 external threads.(M30 hardware included) Max. Tightening Torque: 0.56 N-m (5 in-lbf)																																																																																																													
Operating Temperature	-25 to +55 °C																																																																																																													
Environmental rating	IP65 (IEC60529)																																																																																																													
Operating Humidity	45% to 85% RH (no condensation)																																																																																																													
Insulation Resistance	100M minimum (500 V dc megger)																																																																																																													
Impulse Withstand Voltage	2.5 kV																																																																																																													
Pollution Degree	3																																																																																																													
Overvoltage Category	II																																																																																																													
Contact material / bounce*	Gold plated silver / 20 ms																																																																																																													
Electrical Life	100,000 operations minimum, 250,000 operations minimum at 24 V ac/dc, 100 mA																																																																																																													
Mechanical Life	250,000 operations																																																																																																													
B10d	100,000 (based on ISO13849-1(2006))																																																																																																													
Shock & Vibration Resistance	Operating extremes: 150m/s2 (15G)			Operating extremes: 10 to 500 Hz, amplitude 0.35 mm acceleration 50 m/s2																																																																																																										
LED Illumination	Color: Yellow - 590 nm, Red - 618 nm, Green - 525 nm Flash Rate: 1.6 Hz at 50% duty cycle Voltage/Current: 12 – 30 V dc; 120 mA at 12 V dc, 65 mA at 24 Vdc, 60 mA at 30 V dc, SSA-EB1..LGR.. GREEN only: 12 – 30 V dc; 135 mA @ 12 V dc, 75 mA @ 24 V dc, 70 mA @ 30 V dc																																																																																																													
Electrical Rating	Minimum load: 1 mA @ 5 V ac/dc SSA-EB1xx-..Q5A/Q5B: 3A @ 250 V maximum UL Applications (UL/cUL): 1.5A @ 250 V ac, 1A @ 30 V dc (pilot duty)		SSA-EB1xx-xxED1Q8: 2A at 60 V ac/75 V dc maximum CE Applications: AC-15: 1.5A @ 250 V ac, DC-13: 1A @ 30 V dc																																																																																																											
Rated Insulation Voltage (Ui)	250 V																																																																																																													
Rated Current (Ith)	3A																																																																																																													
Rated Operating Voltage (Ue)	See Electrical Rating																																																																																																													
Rated Operating Current	<p>SSA-EB1xxLxx-02ED1Q5A/Q5B</p> <table border="1"> <tr> <td rowspan="4">Safety Contact (NC)</td> <td rowspan="2">AC 50/60 Hz</td> <td>Resistive Load (AC-12)</td> <td>—</td> <td>—</td> <td>—</td> <td>3A</td> </tr> <tr> <td>Inductive Load (AC-15)</td> <td>—</td> <td>—</td> <td>3A</td> <td>1.5A</td> </tr> <tr> <td rowspan="2">DC</td> <td>Resistive Load (DC-12)</td> <td>2A</td> <td>—</td> <td>0.4A</td> <td>0.2A</td> </tr> <tr> <td>Inductive Load (DC-13)</td> <td>1A</td> <td>—</td> <td>0.22A</td> <td>0.1A</td> </tr> <tr> <td rowspan="4">Monitor Contacts (NO)</td> <td rowspan="2">AC 50/60 Hz</td> <td>Resistive Load (AC-12)</td> <td>—</td> <td>—</td> <td>1.2A</td> <td>0.6A</td> </tr> <tr> <td>Inductive Load (AC-15)</td> <td>—</td> <td>—</td> <td>0.6A</td> <td>0.3A</td> </tr> <tr> <td rowspan="2">DC</td> <td>Resistive Load (DC-12)</td> <td>2A</td> <td>—</td> <td>0.4A</td> <td>0.2A</td> </tr> <tr> <td>Inductive Load (DC-13)</td> <td>1A</td> <td>—</td> <td>0.22A</td> <td>0.1A</td> </tr> </table> <p>SSA-EB1PLxx-02ECQ5A/Q5B (illuminated)</p> <table border="1"> <tr> <td rowspan="4">Safety Contact (NC)</td> <td rowspan="2">AC 50/60 Hz</td> <td>Resistive Load (AC-12)</td> <td>—</td> <td>—</td> <td>—</td> <td>3A</td> </tr> <tr> <td>Inductive Load (AC-15)</td> <td>—</td> <td>—</td> <td>3A</td> <td>1.5A</td> </tr> <tr> <td rowspan="2">DC</td> <td>Resistive Load (DC-12)</td> <td>2A</td> <td>—</td> <td>0.4A</td> <td>0.2A</td> </tr> <tr> <td>Inductive Load (DC-13)</td> <td>1A</td> <td>—</td> <td>0.22A</td> <td>0.1A</td> </tr> </table> <p>SSA-EB1Pxx-xxECQ8 See above for SSA-EB1P-22ECQ8 Monitor Contacts</p> <table border="1"> <tr> <td rowspan="4">Safety Contact (NC)</td> <td rowspan="2">AC 50/60 Hz</td> <td>Resistive Load (AC-12)</td> <td>—</td> <td>2A</td> <td>—</td> <td>—</td> </tr> <tr> <td>Inductive Load (AC-15)</td> <td>—</td> <td>2A</td> <td>—</td> <td>—</td> </tr> <tr> <td rowspan="2">DC</td> <td>Resistive Load (DC-12)</td> <td>2A</td> <td>0.4A</td> <td>—</td> <td>—</td> </tr> <tr> <td>Inductive Load (DC-13)</td> <td>1A</td> <td>0.22A</td> <td>—</td> <td>—</td> </tr> <tr> <td rowspan="2">Auxiliary Output (NO)</td> <td rowspan="2">12 to 30 V dc (from pin 2)</td> <td>Resistive Load (DC-12)</td> <td>0.25A</td> <td>—</td> <td>—</td> <td>—</td> </tr> <tr> <td>Inductive Load (DC-13)</td> <td>0.25A</td> <td>—</td> <td>—</td> <td>—</td> </tr> </table> <p>• The rated operating currents are measured at resistive/inductive load types specified in IEC 60947-5-1. • See "Electrical Rating" above for maximum voltage/current rating per model.</p>						Safety Contact (NC)	AC 50/60 Hz	Resistive Load (AC-12)	—	—	—	3A	Inductive Load (AC-15)	—	—	3A	1.5A	DC	Resistive Load (DC-12)	2A	—	0.4A	0.2A	Inductive Load (DC-13)	1A	—	0.22A	0.1A	Monitor Contacts (NO)	AC 50/60 Hz	Resistive Load (AC-12)	—	—	1.2A	0.6A	Inductive Load (AC-15)	—	—	0.6A	0.3A	DC	Resistive Load (DC-12)	2A	—	0.4A	0.2A	Inductive Load (DC-13)	1A	—	0.22A	0.1A	Safety Contact (NC)	AC 50/60 Hz	Resistive Load (AC-12)	—	—	—	3A	Inductive Load (AC-15)	—	—	3A	1.5A	DC	Resistive Load (DC-12)	2A	—	0.4A	0.2A	Inductive Load (DC-13)	1A	—	0.22A	0.1A	Safety Contact (NC)	AC 50/60 Hz	Resistive Load (AC-12)	—	2A	—	—	Inductive Load (AC-15)	—	2A	—	—	DC	Resistive Load (DC-12)	2A	0.4A	—	—	Inductive Load (DC-13)	1A	0.22A	—	—	Auxiliary Output (NO)	12 to 30 V dc (from pin 2)	Resistive Load (DC-12)	0.25A	—	—	—	Inductive Load (DC-13)	0.25A	—	—	—
Safety Contact (NC)	AC 50/60 Hz	Resistive Load (AC-12)	—	—	—	3A																																																																																																								
		Inductive Load (AC-15)	—	—	3A	1.5A																																																																																																								
	DC	Resistive Load (DC-12)	2A	—	0.4A	0.2A																																																																																																								
		Inductive Load (DC-13)	1A	—	0.22A	0.1A																																																																																																								
Monitor Contacts (NO)	AC 50/60 Hz	Resistive Load (AC-12)	—	—	1.2A	0.6A																																																																																																								
		Inductive Load (AC-15)	—	—	0.6A	0.3A																																																																																																								
	DC	Resistive Load (DC-12)	2A	—	0.4A	0.2A																																																																																																								
		Inductive Load (DC-13)	1A	—	0.22A	0.1A																																																																																																								
Safety Contact (NC)	AC 50/60 Hz	Resistive Load (AC-12)	—	—	—	3A																																																																																																								
		Inductive Load (AC-15)	—	—	3A	1.5A																																																																																																								
	DC	Resistive Load (DC-12)	2A	—	0.4A	0.2A																																																																																																								
		Inductive Load (DC-13)	1A	—	0.22A	0.1A																																																																																																								
Safety Contact (NC)	AC 50/60 Hz	Resistive Load (AC-12)	—	2A	—	—																																																																																																								
		Inductive Load (AC-15)	—	2A	—	—																																																																																																								
	DC	Resistive Load (DC-12)	2A	0.4A	—	—																																																																																																								
		Inductive Load (DC-13)	1A	0.22A	—	—																																																																																																								
Auxiliary Output (NO)	12 to 30 V dc (from pin 2)	Resistive Load (DC-12)	0.25A	—	—	—																																																																																																								
		Inductive Load (DC-13)	0.25A	—	—	—																																																																																																								
Design Standards	Compliant with EN/IEC 60497-1 / -5-1, ISO 13850, ANSI B11.19 , ANSI NFPA79, IEC 60204-1																																																																																																													
Certifications	 																																																																																																													

XS26-2

Safety Controller



- Easy to both program and install while providing scalable flexibility to meet your growing automation needs.
- Allows up to eight expansion modules
- Configuration software free of charge
- Real-time live display feedback
- Intuitive functional diagram configuration; logic function blocks including AND, OR, XOR, NAND, NOR, SR Flip-flop, RS Flip-flop
- Ethernet models available providing up to 256 status outputs and non-safety virtual outputs
- Applications see page 13, 21, 27, 33

Controller

Description	Model
Expandable	XS26-2
Expandable + Display	XS26-2d
Expandable + Ethernet	XS26-2e
Expandable + Display + Ethernet	XS26-2de

Expansion Modules

Description	Output Configuration	Model*
8 Pin Safety input module	NA	XS8si
16 Pin Safety input module	NA	XS16si
Safety output module	2 dual channel PNP	XS2so
Solid-state safety output module	4 dual channel PNP	XS4so
Safety relay output module	2 NO/1NC	XS1ro
Safety relay output module	4 NO/2 NC	XS2ro

* All models come with screw terminals

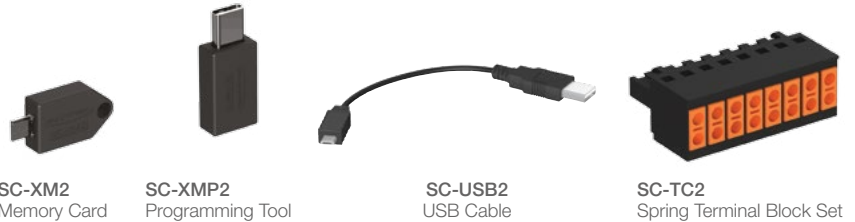

Specifications

Power	24 V dc, ± 20% Ethernet models: add 40 mA Display models: add 20 mA Expandable models: add 3.6 A max. bus load
Safety Inputs (and Convertible I/O when used as inputs)	Input On threshold: > 15 V dc (guaranteed on), 30 V dc max. Input Off threshold: < 5 V dc and < 2 mA, -3 V dc min. Input On current: 5 mA typical at 24 V dc, 50 mA peak contact cleaning current at 24 V dc Input lead resistance: 300 Ω max. (150 Ω per lead) Input requirements for a 4-wire Safety Mat: <ul style="list-style-type: none"> • Max. capacity between plates: 0.22μF • Max. capacity between bottom plate and ground: 0.22μF • Max. resistance between the 2 input terminals of one plate: 20 Ω
Solid State Safety Outputs	Input On threshold: > 15 V dc (guaranteed on), 30 V dc max. Input Off threshold: < 5 V dc and < 2 mA, -3 V dc min. Input On current: 5 mA typical at 24 V dc, 50 mA peak contact cleaning current at 24 V dc Input lead resistance: 300 Ω max. (150 Ω per lead) Input requirements for a 4-wire Safety Mat: <ul style="list-style-type: none"> • Max. capacity between plates: 0.22 μF • Max. capacity between bottom plate and ground: 0.22 μF • Max. resistance between the 2 input terminals of one plate: 20 Ω
Response and Recovery Times	See Configuration Summary in the data sheet
Environmental Rating	NEMA 1 (IEC IP20), for use inside NEMA 3 (IEC IP54) or better enclosure
Operating Conditions	Temperature range: 0 to +55 °C
Mechanical Stress	Shock: 15g for 11 milliseconds, half sine, 18 shocks total (per IEC 61131-2) Vibration: 3.5 mm occasional / 1.75 mm continuous @ 5Hz to 9Hz, 1.0g occasional and 0.5g continuous @ 9Hz to 150Hz: all at 10 sweep cycles per axis (per IEC 61131-2)
Removable Terminals	Important: Clamp terminals are designed for 1 wire only. If more than 1 wire is connected to a terminal, a wire could loosen or become completely disconnected from the terminal, causing a short. Wire size: 24 to 12 AWG (0.20 to 3.13 mm ²) Wire strip length: 7 to 8 mm (0.275 in to 0.315 in)
Design Standards	Category 4, PL e (EN ISO 13849) SIL CL 3 (IEC 62061, IEC 61508)

Certifications



VE Series

Versatile, Easy-To-Use Smart Cameras



- Available in 2MP (1600 x 1200 pixels), 1.3MP (1280 x 1024 pixels) and WVGA (752 x 480 pixels) models, all with the same powerful inspection capabilities
- Runtime editing capability reduces costly downtime and the software emulator allows for offline building and troubleshooting of applications
- Factory communications (EtherNet/IP, Modbus/TCP, PROFINET and RS-232 Serial) for integration on the manufacturing floor
- Two-line, eight-character onboard display provides inspection information and focus number and makes it easy to update sensor settings, facilitating fast product changeover
- Robust metal housing with optional lens covers to achieve IP67 rating for use in harsh environments with heat, vibration, or moisture
- Applications see page 32

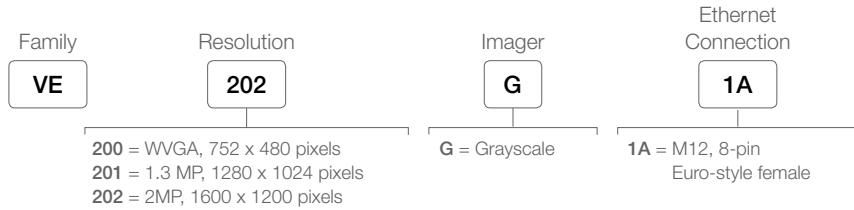

C-Mount lenses, lens covers, and bandwidth filters are available on bannerengineering.com



SMBVERA



SMBVEMP
Mounting plate with M8x1.25, 10-32, and 1/2-20 adapter holes



12-pin Euro-Style with Shield

RJ45 to Ethernet 8-pin M12 Euro (Cat5e shielded)

MQDC2S-1215
MQDC2S-1215RA
5 m (15')

STP-M12-815
5 m (15')

Additional lengths available on bannerengineering.com

Specifications

Power	12 to 30 V dc	
Discrete I/O	1 Trigger IN	5 programmable I/O
Output Configuration	Optically isolated	
Lens	C-mount	
Communication	10/100/1000 Mbps Ethernet, Serial RS-232	
Communication Protocols	Ethernet/IP, Modbus/TCP, PCCC, PROFINET, TCP/IP, FTP, and RS-232	
Acquisition	256 grayscale levels Frames per Second: VE202G1A: 50 fps, max. depending on inspection settings VE202G2A: 50 fps, VE200G1A: 60 fps, VE201G1A: 60 fps Image Size: 752 x 480 pixels = VE200G1A 1280 x 1024 pixels = VE201G1A 1600 x 1200 pixels = VE202G1A, VE202G2A	
Construction	Housing: Aluminum	Display Label: Polyester
Connections	Communications: M12, 8-pin Euro-style male Light Connector: M8, 3-pin Pico-style female Power, Discrete I/O: M12, 12-pin Euro-style female	
Software Tools	Average Gray, Bead, Blemish, Blob, Line Detect, Circle Detect, Edge, Locate, Logic, Match, Math, Measure, Object	
Environmental Rating	IEC IP67 with optional lens cover	

Certifications



IVu TG Plus Gen2



Image Sensor

- Image sensor combines the simplicity of a photoelectric sensor and the intelligence of a vision sensor, providing high-performance inspection capabilities at your fingertips
- All-inclusive image sensor with lens, light, IO and touch screen programming
- Optional remote touch screen for programming
- Profinet® communication protocol to simplify communications with some of the most commonly used industrial controllers in factory automation
- Supports the ability to obtain results and command rapid product changeovers over TCP/IP, EtherNet/IP, Modbus/TCP protocols or PROFINET
- Ability to change parameters on the fly
- Additional sort tools, multi-tool and the ability to store up to 30 inspections
- Applications see page 26, 31

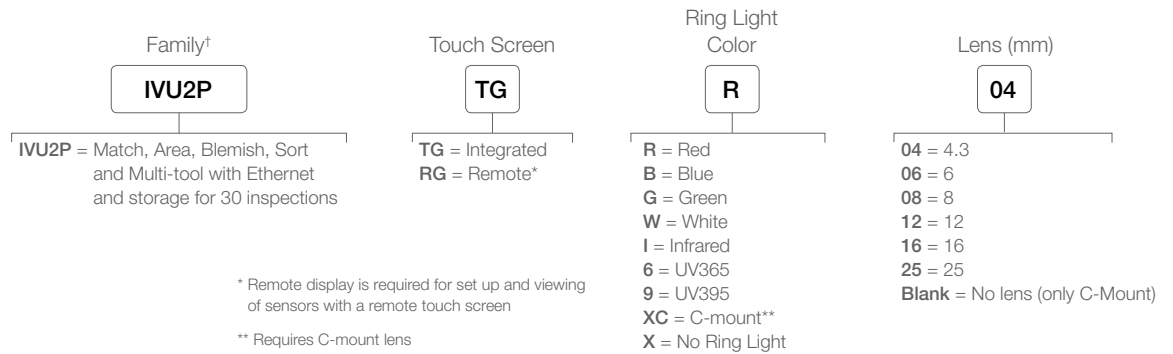

Sensors with Remote Touch Screen

RDM35 Remote Touch Screen (sold separately)





Power

M12/Euro-Style
with Shield

12-Pin
MQDC2S-1215
5 m (15')
MQDC2S-1215RA
5 m (15')



USB to Pico

4-Pin Pico
PSG-4M-403-USB
0.9 m (3')





Ethernet

RJ45 to 4-Pin
Pico QD
TG Plus only

IVUC-E-415
5 m (15')

Additional lengths available on
bannerengineering.com

iVu & iVu Plus Specifications

General	
Supply Voltage	10-30 V dc
Demo Mode	Full tool functionality on canned images
Sensor Lock	Optional password protection
Integrated Ring Light	Red, IR, Green, Blue, White, UV or no integrated ring light
Imager	1/3 inch CMOS 752 x 480 pixels; adjustable Field-of-View (FOV)
Lens Mount	M12 X 1 mm thread (c-mount lens); microvideo lens 4.3, 6, 8, 12, 16, 25 mm
Output Rating	150 mA
Exposure Time	0.1 milliseconds to 1.049 seconds
Construction	Black Valox™ sensor housing; acrylic window iVu Plus Integrated: Die cast zinc and Black Valox™
External Strobe Output	+ 5 V dc
Environmental Rating	IP67
Model Specific	
Power Connection	Integrated and remote touch screen: 12-pin Euro-style (M12) male connector Accessory cordset required for operation; QD cordsets are ordered separately.
Supply Current	850 mA max. (exclusive of I/O load)
USB 2.0 Host	Integrated and remote touch screen: 4-pin Pico-style (M8) female connector Optional USB cordset required for operation of USB Thumb Drive. QD cordsets are ordered separately.
Ethernet Connection	iVu Plus TG: 4-pin Pico-style (M8) male connector. Ethernet cordsets are ordered separately.
Output Configuration	NPN or PNP, software on-screen selectable
Tools	Area, Blemish, Match and Sort
Display	Integrated touch screen: 68.5 mm (2.7") LCD Color Integrated Display 320 x 240 pixels Remote touch screen: See RD35 Remote Display specifications
Acquisition	100 fps (frames per second) max.
Operating Conditions	Stable Ambient Temperature: Integrated touch screen: 0 to +45 °C Remote touch screen: 0 to +40 °C
Remote Display Connection (Remote Touch Screen Models Only)	8-pin Euro-style (M12) female connector. Accessory cordset required for remote display; QD cordsets are ordered separately.
Certifications	 NOTE: iVu Plus remote must use Euro QD power cordset for CE compliance. 

iVu Remote Display Specifications

Screen Size	3.5" diagonal	Stylus	Delrin
LCD Aspect Ratio	4:3	Display Weight	4.8 oz (RD35), 12 oz (RDM35)
Display Resolution	320 x 240 RGB	Bracket & Stylus Weight	1.1 oz
Viewing Angle	60 degrees left, and 60 degrees right, 50 degrees up, and 55 degrees down	Connection	Molex HandyLink connector
Housing Material	Zinc Zamac #3 (RDM35), Polycarbonate (RD35)	Operating Temperature	0° to + 40 °C
Bracket Material	Delrin (RD35), ABS (RDM35)		



iVu Plus BCR Gen2

Bar Code Reader (BCR)

- Powerful, affordable inspection solution solves a wide variety of simple and complex applications
- Solve a variety of linear and 2D bar code applications
- First-time users can have it up and running in minutes
- Optional remote touch screen for programming
- Ability to change parameters on the fly
- Ethernet communication available
- Capable of storing and controlling up to 30 inspections for fast product change over
- Applications see page 11, 18, 31

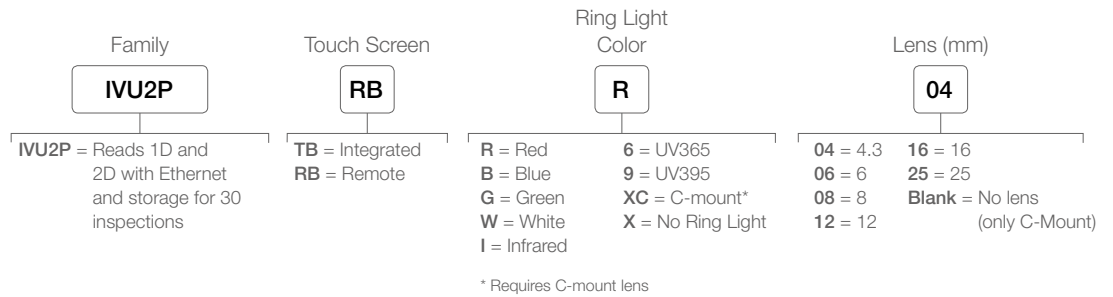

Accessories are shown on previous page.

Specifications

General	
Supply Voltage	10-30 V dc
Demo Mode	Full tool functionality on canned images
Sensor Lock	Optional password protection
Integrated Ring Light	Red, IR, Green, Blue, White, UV or no integrated ring light
Imager	1/3 inch CMOS 752 x 480 pixels; adjustable Field-of-View (FOV)
Lens Mount	M12 X 1 mm thread (c-mount lens); microvideo lens 4.3, 6, 8, 12, 16, 25 mm
Output Rating	150 mA
Exposure Time	0.1 milliseconds to 1.049 seconds
Construction	Black PBT sensor housing; acrylic window iVu Plus Integrated: Die cast zinc and Black PBT
External Strobe Output	+ 5 V dc
Environmental Rating	IP67

Model Specific	
Power Connection	12-pin Euro-style (M12) male connector Accessory cordset required for operation; QD cordsets are ordered separately.
Supply Current	850 mA max. (exclusive of I/O load)
USB 2.0 Host	4-pin Pico-style (M8) female connector Optional USB cordset required for operation of USB Thumb Drive. QD cordsets are ordered separately.
Ethernet Connection	4-pin Pico-style (M8) male connector. Ethernet cordsets are ordered separately.
Output Configuration	NPN or PNP, software selectable
Display	Integrated touch screen: 68.5 mm (2.7") LCD Color Integrated Display 320 x 240 pixels Remote touch screen: See RD35 Remote Display specifications
Acquisition	Integrated and remote touch screen: 100 fps (frames per second) max.
Operating conditions	Stable Ambient Temperature: Integrated touch screen: 0 to +45 °C Remote touch screen: 0 to +40 °C

Remote Display connection
(Remote Touch Screen Models Only) 8-pin Euro-style (M12) female connector Accessory cordset required for remote display; QD cordsets are ordered separately.

Certifications



NOTE: iVu Plus remote must use Euro QD power cordset for CE compliance.



Remote display specifications on previous page.



WLS15 Series

Low Profile LED Strip Light

- Improves visibility, safety, and efficiency
- 15 mm low profile fits in tight spaces that other lights cannot
- Installs in minutes without impacting existing application framework
- Professional quality and certified product
- Applications see page 11, 20, 26

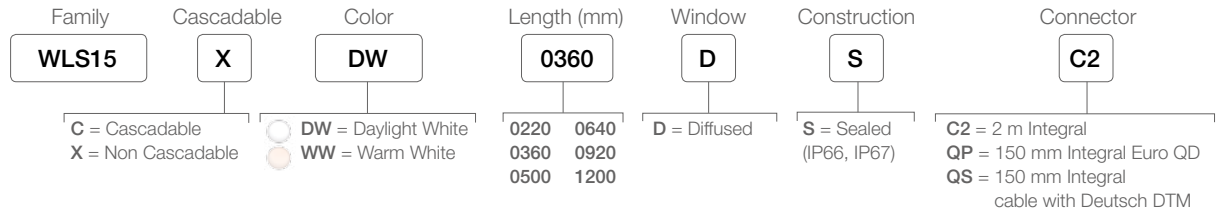

LMBWLS15



LMBWLS15-150S



LMBWLS15MAG



4-pin Euro-Style

MQDC-415
 5 m (15')
MQDC-415RA
 5 m (15')

2-pin Deutsch
 Single-ended cordset with straight connectors

DTMC-215
 5 m (15')

Additional cordset lengths available on bannerengineering.com

Specifications

Supply Voltage and Current	12 V dc or 24 V dc nominal Absolute operational limits of 10 V dc to 15 V dc and 20 V dc to 27 V dc Use only with a suitable Class 2 power supply (UL) or a SELV power supply (CE) Light can be PWM dimmed between 25% to 100% with a frequency up to 1000 Hz						
	Light Length (mm)	Typical Current (A) at 25 °C		Maximum Current (A) at -40 °C		Lumens	
		12 V dc	24 V dc	12 V dc	24 V dc	Daylight White	Warm White
	0220	0.19	0.10	0.24	0.12	175	170
	0360	0.38	0.20	0.48	0.24	350	340
	0500	0.57	0.30	0.72	0.36	525	510
	0640	0.76	0.40	0.96	0.48	700	680
	0920	1.14	0.60	1.44	0.72	1050	1020
	1200	1.52	0.80	1.92	0.96	1400	1360
Light Characteristics	Color Temperature (CCT): Daylight white: 5,000 K Warm white: 3,000 K CRI: 80 minimum						
Construction	Clear anodized aluminum inner housing; Polycarbonate outer housing, Polyamide end caps						
Mounting	Integral mounting slots for M4 (#8) screws, tighten to 5 in-lbf max torque Multiple bracket options available						
Environmental Rating	Rated IEC IP66 and IEC IP67 Suitable for wet locations per UL 2108						
Operating Conditions	Temperature: -40 to +70 °C Storage Temperature: -40 to +70 °C						
Application Notes	When connecting cascadable lights in series it is important not to exceed maximum current limitations: Maximum length of light at 12 V dc = 2.4 m Maximum length of light at 24 V dc = 6 m						

Certifications



WLS27 Series

LED Light Bar

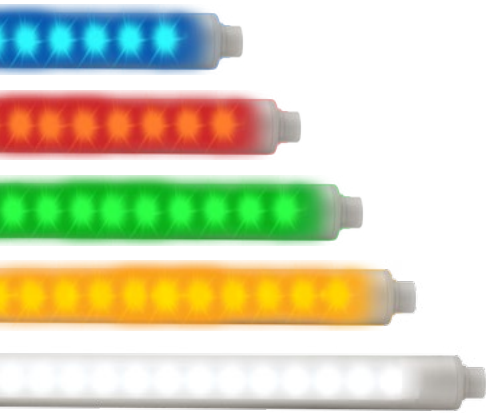

- Encased in shatterproof, UV-stabilized, copolyester shells
- Round shape makes them suitable for laminar airflow applications
- Rugged, water-resistant IP66, IP67 and IP69K design
- Daisy chain power to multiple lights
- Capability to dim lights using the wiring pinout (Hi/Lo/Off)
- Automatic temperature protection built into the unit extends the product life
- Single- and dual-colored models available
- Applications see page 12, 19, 31

Single Color

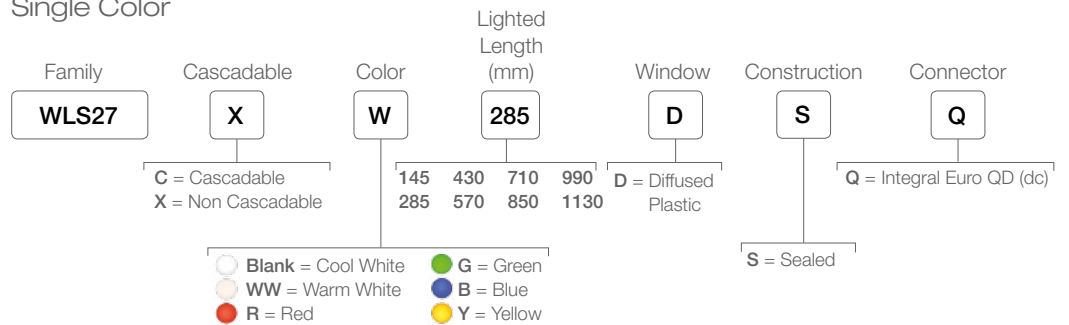

Dual-Color

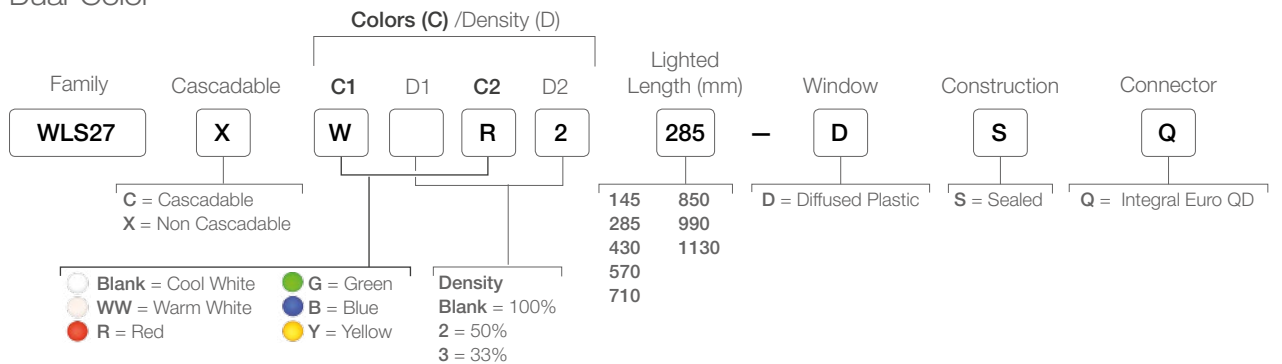



LMBWLS27EC

LMBWLS27H

LMBWLS27U

LMBWLS27SP

Standard

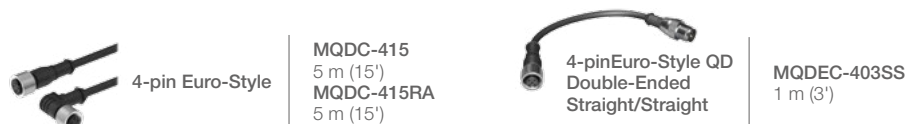

4-pin Euro-Style

MQDC-415
5 m (15')
MQDC-415RA
5 m (15')

4-pin Euro-Style QD Double-Ended Straight/Straight

MQDEC-403SS
1 m (3')

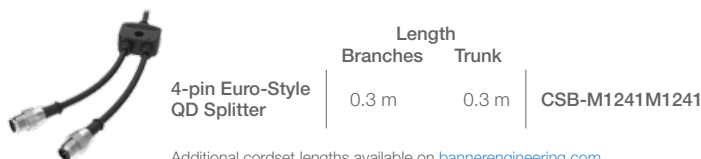

4-pin Euro-Style QD Splitter

Length	Branches		Trunk
	0.3 m	0.3 m	

CSB-M1241M1241

Additional cordset lengths available on bannerengineering.com

IP69K Washdown



4-pin M12 Euro-Style Washdown Cordset Straight connector models only

MQDC-WDSS-0415
5 m (15')

4-pin Euro-Style QD Double-Ended Washdown Straight/Straight

MQDEC-WDSS-403SS
1 m (3')

Additional cordset lengths available on bannerengineering.com

WLS27 Specifications

Supply Voltage and Current	12 to 30 V dc see data sheet for details by length	
----------------------------	--	--

Lumens

Length (mm)	One-Color WLS27 Lumens (Typical @ 25 °C)						Typical Wattage* (Watts)	Length (mm)	One-Color WLS27 Lumens (Typical @ 25 °C)						Typical Wattage* (Watts)				
	Cool White		Warm White		Red	Green			Blue	Yellow	Cool White		Warm White			Red	Green	Blue	Yellow
	325	325	55	180							40	50	3.6	710					
145	325	325	55	180	40	50	3.6	710	1625	1625	275	900	200	250	18.5				
285	650	650	110	360	80	100	7.2	850	1950	1950	330	1080	240	300	22.1				
430	975	975	165	540	120	150	11.0	990	2275	2275	385	1260	280	350	25.9				
570	1300	1300	220	720	160	200	14.6	1130	2600	2600	440	1440	320	400	29.8				

*Typical operating wattage is measured at 24 V dc

Light Characteristics	Color: Cool white Color temperature (CCT): 6000–7100K
Useful Life	Lumen Maintenance - L70 When operating within specifications, output will decrease less than 30% after 50,000 hours.
Construction	Clear anodized aluminum housing; FDA-grade copolyester outer housing
Mounting	Bracket LMBWLS27EC included (2 for lights up to 570 mm or 3 for lights 710 mm and longer); see datasheet for additional options
Environmental Rating	IEC IP66, IP67, and IP69K, per DIN 40050
Operating Conditions	-40 to +70 °C
Certifications	  



WLB32 Series

LED Light Bar

- Banner's WLB32 is an ultra-bright LED fixture that features an even light output for a no glare 'glow'
- Highly energy efficient for overall cost savings
- High/Low/OFF switch
- Daisy chain power to multiple lights
- Metal housing, shatterproof window
- Easy installation with snap clips, or a choice of magnetic or angle brackets
- Applications see page 11, 20, 26

WLB32

Example Model Number: WLB32C285PBQ

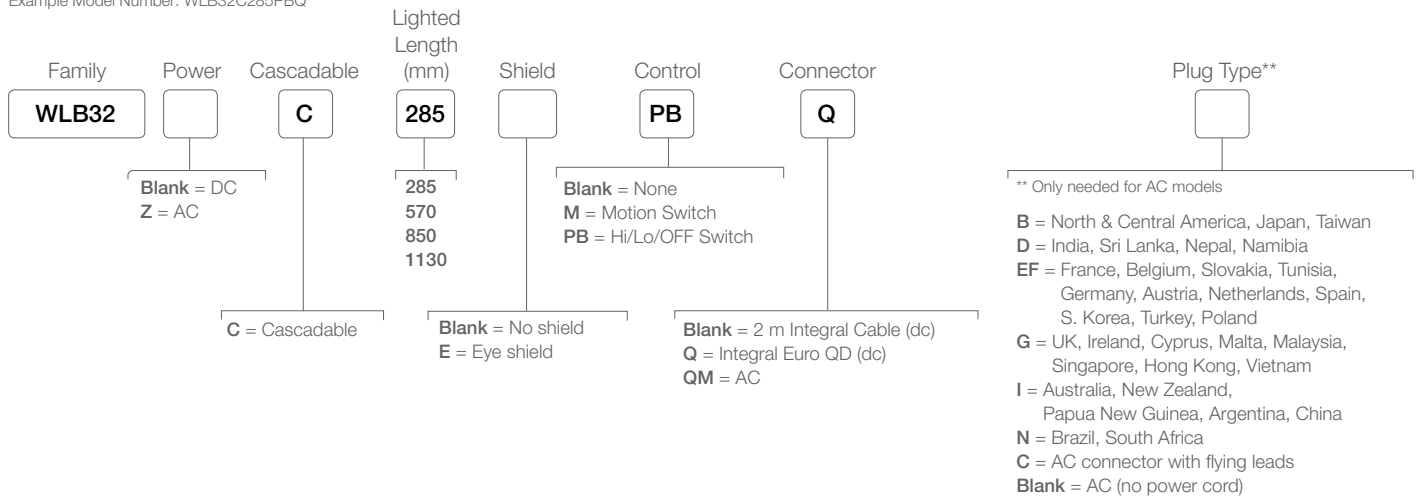

Cascadable



AC or DC



Hi/Low/Off Switch



Motion Detection



Eye Shield



LMBWLB32



LMBWLB32-180S



LMBWLB32MAG



LMBWLB32U



LMBWLB32UT

Cordsets for DC Models



4-pin Euro-Style

MQDC-415
5 m (15')
MQDC-415RA
5 m (15')



4-pin Euro-Style QD
Double-Ended
Straight/Straight or
Straight/Right-angle

MQDEC-403SS
1 m (3')
MQDEC-403RS
1 m (3')



4-pin Euro-Style
QD Splitter

	Length	
	Branches	Trunk
	0.3 m	0.3 m

CSB-M1241M1241

Additional cordset lengths available on bannerengineering.com

Cordsets for AC Models



Double-Ended
NEMA 5-15 grounded
(IEC Type B)

LQMAC-306B
2 m (6.5')





Double-Ended
For Cascading
Straight/Straight

LQMAEC-312SS
3 m (12')

Additional cordset lengths available on
bannerengineering.com

Specifications

Supply Voltage and Current	12 to 30 V dc 90 to 264 V ac								
	Lighted Length (mm)	Max Current Draw (A)		Typical Current Draw (A)					Lumens
		DC	AC (at 90 V ac)	12 V DC	24 V DC	30 V DC	120 V ac	230 V ac	
285	0.8	0.125	0.66	0.31	0.24	0.075	0.045	650	
570	1.6	0.250	1.36	0.62	0.48	0.150	0.080	1300	
850	2.4	0.375	2.19	0.93	0.72	0.225	0.115	1950	
1130	3.2	0.500	3.02	1.24	0.96	0.300	0.150	2600	

Light Characteristics	Color: Daylight white Color temperature (CCT): 5000K (±300K)
Useful Life	Lumen Maintenance - L70 When operating within specifications, output will decrease less than 30% after 50,000 hours.
Push Button	II = 100% intensity I = 50% intensity 0 = Off
Construction	Anodized aluminum housing; polycarbonate window and end caps; stainless steel mounting brackets
Mounting	Snap clips; magnetic mount or swivel bracket accessories available
Environmental Rating	IEC IP50
Operating Conditions	DC models: -40 C to 70 °C AC models: -25 to 45 °C
Certifications	  



WLB92 Series

LED Light Bar

- Increase worker productivity and ergonomics with bright, high-quality, uniform light
- Durable light stands up in your environment with a rugged metal housing and shatterproof light cover
- No maintenance time or cost with long-life, energy-efficient LEDs
- Flexibility to place light where needed with ac and dc models
- Easy installation with variety of mounting options: surface, swivel, snap and hanging brackets
- AC models are DLC certified and have a five year warranty
- Applications see page 26

24 V DC

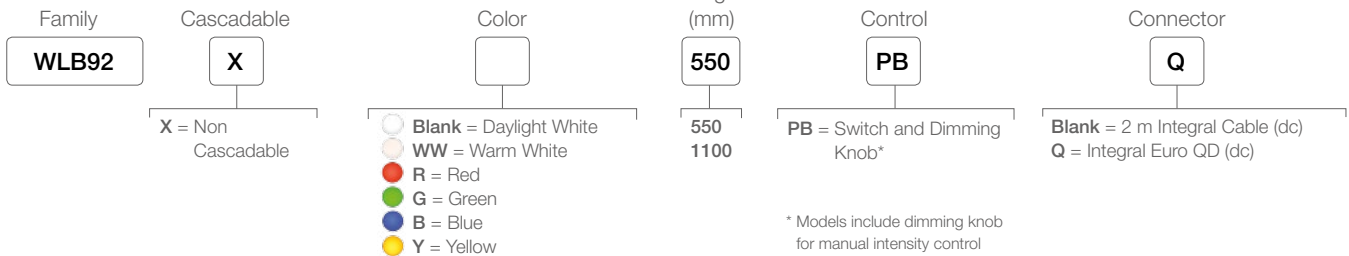

100-277 V AC

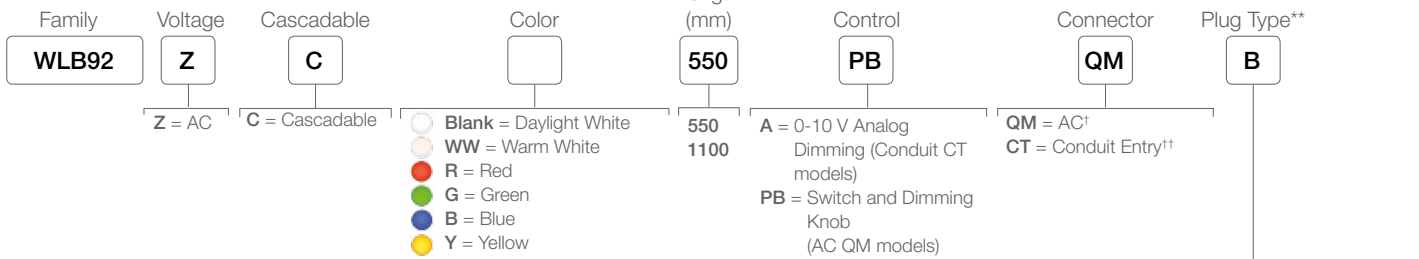

† Models with a connector include ON/OFF switch as well as a dimming knob for intensity control

†† Conduit entry models include dimmability via a 0 to 10 V input circuit

** Only needed for AC QM models

- B** = North & Central America, Japan, Taiwan
- D** = India, Sri Lanka, Nepal, Namibia
- EF** = France, Belgium, Slovakia, Tunisia, Germany, Austria, Netherlands, Spain, S. Korea, Turkey, Poland
- G** = UK, Ireland, Cyprus, Malta, Malaysia, Singapore, Hong Kong, Vietnam
- I** = Australia, New Zealand, Papua New Guinea, Argentina, China
- N** = Brazil, South Africa
- C** = AC connector with flying leads
- Blank** = AC (no power cord)



LMBWLB92



LMBWLB92CLIP



LMBWLB92HK5



LMBLWB92S



LMBWLB92RAS



4-pin Euro-Style

MQDC-415
5 m (15')
MQDC-415RA
5 m (15')





Double-Ended
For Cascading
straight/straight

LQMAEC-306SS
2 m (6.5')

Additional cordset lengths available on
bannerengineering.com

Specifications

Supply Voltage and Current	24 V dc +/- 10% 100 to 277 V ac							
	Lighted Length (mm)	Max Current Draw (A)		Typical Current Draw (A)				Lumens
		DC	AC (at 90 V ac)	24 V DC	120 V ac	230 V ac	277 V ac	
	550	1.75 A	0.425 A	1.45 A	0.295 A	0.160 A	0.145 A	3130
	1100	3.5 A	0.850 A	2.9 A	0.590 A	0.310 A	0.260 A	6500
Light Characteristics	Color: Daylight white Color temperature (CCT): 5000K (±300K)				Color: Warm white Color temperature (CCT): 3,000 K			
Useful Life	Lumen Maintenance - L70 When operating within specifications, output will decrease less than 30% after 50,000 hours.							
Construction	Anodized aluminum housing; polycarbonate window and end caps							
Mounting	Several options available; see above and datasheet							
Environmental Rating	IEC IP40							
Operating Conditions	See datasheet							
Certifications	   AC daylight white models only							

TL50 Tower Lights

Preconfigured Tower Lights



LASER
MARKING
AVAILABLE



- Exceptionally bright, highly visible from a distance
- Install quickly and easily with no assembly required
- Clearly evident on/off status
- Versatile mounting options
- Compact, sleek, rugged design with IP67 models available
- Audible alert: continuous, pulsed and staccato models available
- Models available with IO-Link communication
- Applications see page 20





SMB30A



SMB30MM



SMBAMS30P



SMB30RAVK



Euro-Style

3 Lights/4-Pin	4 Lights/5-Pin	5+ Lights/8-Pin
MQDC-415 5 m (15')	MQDC1-515 5 m (15')	MQDC2S-815 5 m (15')
MQDC-415RA 5 m (15')	MQDC1-515RA 5 m (15')	MQDC2S-815RA 5 m (15')



Micro-Style

3 Lights/4-Pin	4 Lights/5-Pin
MQADC-415 5 m (15')	MQDAC2-515 5 m (15')
MQADC-415RA 5 m (15')	MQDAC2-515RA 5 m (15')

Additional lengths available on bannerengineering.com



Elevated Mount System



Foldable Bracket

Additional mounting options are available on bannerengineering.com

Specifications

Supply Voltage and Current	DC models: 18 to 30 V dc (10% max. ripple); or 21 to 27 V ac Standard Brightness: Indicators: 45 mA max. current per LED color Standard Audible Alarm (IP50): @ 25 mA max. current Sealed Audible Alarm (IP67): 35 mA max. current Omni-Directional Sealed Audible Alarm: 45 mA max. current High Brightness: max. current per LED color: Indicators: 18 V dc—100 mA; 30 V dc—60 mA; 21 V ac—80 mA; 27 V ac—70 mA Standard Audible (IP50): 25 mA max. current Sealed Audible Alarm (IP67): 35 mA max. current Audible only: @ 45mA max. AC models: 100 to 240 V ac; 50 or 60 Hz
Indicators	LEDs are independently selected— Green, Yellow, Red, Blue, White, Turquoise, Orange, Violet, Sky Blue or Magenta; 1-7 colors depending on model
Supply Protection Circuitry	Protected against reverse polarity and transient voltages
Input Response Time	Indicators ON/OFF (dc): 10 milliseconds (max.) Indicators ON/OFF (ac): 500 milliseconds (max.)
Audible Alarm	Audible measurements are made in the direction sound exits the device. For standard audible models, this is the top of the unit (when mounted vertically, sound is directed toward the ceiling). For sealed audible models (IP67), sound exits the vented openings in the side of the unit, which should be oriented so that the sound is directed toward the machine operator(s). In environments with high ambient noise levels or high ceilings that absorb sound, the sealed version is recommended. Standard Audible Alarm: 2.7 KHz ± 500 Hz oscillation frequency; max. intensity 92 db @ 1 meter (typical) Sealed Audible Alarm: 29 KHz to 250 Hz oscillation frequency; max. intensity 94 db @ 1 meter (typical) Omni-Directional Sealed Audible Alarm with Intensity Adjustment: 2.1 KHz ± 250 Hz oscillation frequency; max intensity 95 dB at 1 meter (3.3 ft) (typical)
Audible Adjustments	Standard Audible Alarm: Unscrew the cover (up to 1.5 turns max.) to adjust the audible intensity. (Do not exceed 1.5 turns or the cover may detach during operation.) For max. intensity, rotate the center plug 180° counterclockwise to remove it. Sealed Audible Alarm and Omni-Directional Sealed Audible Alarm with Intensity Adjustment: Rotate the front cover until the desired intensity is reached.
Construction	Bases and Covers: ABS Light Segment: Polycarbonate
Environmental Rating	General-Purpose: IEC IP67 Audible: IEC IP50 or IEC IP67, depending on model
Operating Conditions	General-Purpose: -40 to +50 °C Audible: -20 to +50 °C Relative Humidity: 95% @ 50 °C (non-condensing) Storage Temperature: -40 to +70 °C
Certifications	 

TL70 Series

Tower Lights

- Light segments have user-selectable solid ON or flashing
- Up to six light segments (six color options) or five segments plus an audible in one device
- Rugged, water-resistant IP65 housing with UV stabilized material
- Bright, uniform indicator segments appear gray when off to eliminate false indication from ambient light
- Applications see page 37



LASER MARKING AVAILABLE

Preassembled DC

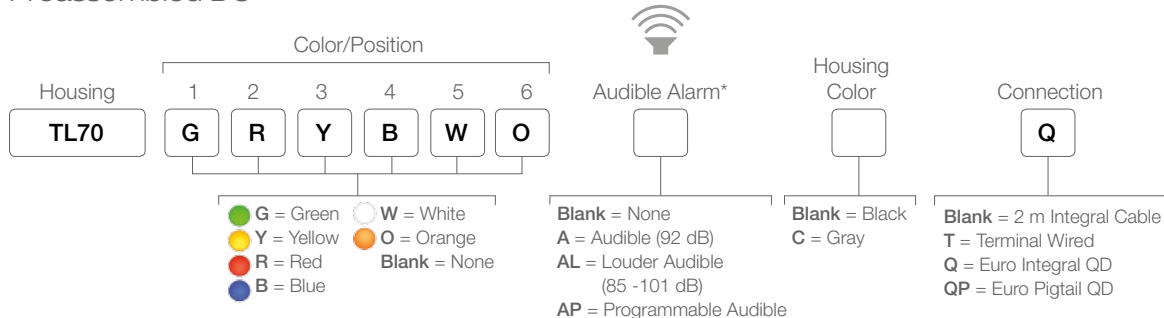

Preassembled AC

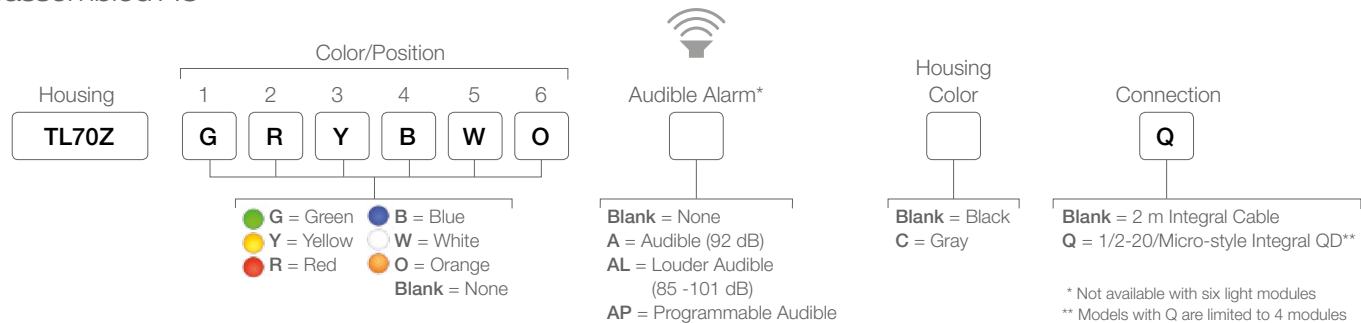

Preassembled Wireless

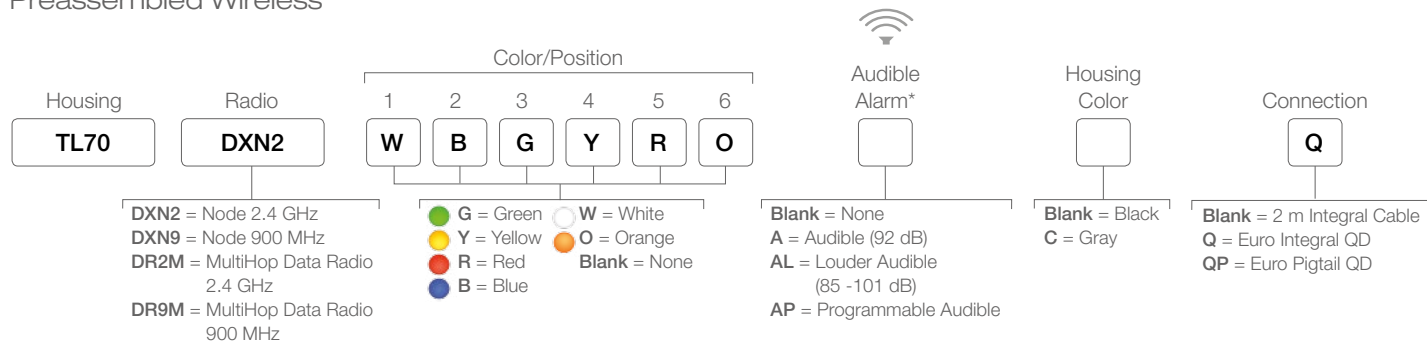

Requires Gateway or master radio of the same frequency



SMB30A



SMB30MM



SMBAMS30P



SMB30RAVK



Euro-Style

3 Lights/4-Pin	4 Lights/5-Pin	5+ Lights/8-Pin
MQDC-415 5 m (15')	MQDC1-515 5 m (15')	MQDC2-815 5 m (15')
MQDC-415RA 5 m (15')	MQDC1-515RA 5 m (15')	MQDC2-815RA 5 m (15')





Micro-Style
For AC models

3-Lights/4-Pins	4 Lights/5-Pin
MQAC2-415 5 m (15')	MQAC2-515 5 m (15')

Additional cordset lengths available on bannerengineering.com

Specifications

Supply Voltage and Current	12 to 30 V dc Indicators—Maximum current per LED color: Blue, Green, White: 420 mA at 12 V dc; 145 mA at 30 V dc Red, Yellow, Orange: 285 mA at 12 V dc; 120 mA at 30 V dc Audible: Standard: 30 mA at 12 to 30 V dc Loud: 350 mA at 12 V dc; 110 mA at 30 V dc Multitone: 270 mA at 12 V dc; 110 mA at 30 V dc Programmable: 250 mA at 12 V dc; 110 mA at 30 V dc	100 to 240 V ac; 50/60 Hz Maximum current per color or audible module: 70 mA at 120 V ac and 60 Hz 50 mA at 230 V ac and 50 Hz
Supply Protection Circuitry	Protected against reverse polarity and transient voltages	
Indicator Response Time	DC models: OFF Response: 150 μ s (maximum) at 12 to 30 V dc ON Response: 180 ms (maximum) at 12 V dc; 50 ms (maximum) at 30 V dc	AC models: OFF Response: 150 μ s (maximum) at 12 to 30 V dc ON Response: 180 ms (maximum) at 12 V dc; 50 ms (maximum) at 30 V dc
Audible Alarm	2.6 KHz \pm 250 Hz oscillation frequency; maximum intensity 92 dB at 1 m (3.3 ft) (typical)	
Audible Adjustments	Rotate the cover until the desired volume is reached Change in sound intensity from fully open to fully closed is 8 dB	
Radio Range (Wireless Models)	900 MHz, 1 Watt (Internal antenna): Up to 3.2 km (2 miles) 2.4 GHz, 65 mW (Internal antenna): Up to 1000 m (3280 ft) with line of sight	
Minimum Separation Distance (Wireless Models)	900 MHz, 1 Watt: 4.57 m (15 ft) 2.4 GHz, 65 mW: 0.3 m (1 ft)	
Construction	Bases, segments and Covers: Polycarbonate	
Environmental Rating	IEC IP65	
Operating Conditions	-40 to +50 °C Relative Humidity: 95% @ 50 °C (non-condensing) Storage Temperature: -40 to +70 °C	
Certifications	 	

K50L2 and K30L2

Domed Indicators



- Get seven colors via only three inputs
- Save controller outputs and wiring
- Improve production efficiency through enhanced visual management
- Install wherever you need indication to improve communication and productivity
- Standardize to simplify ordering and spare parts
- Collaborate with Banner on custom models
- Applications see page 12, 19

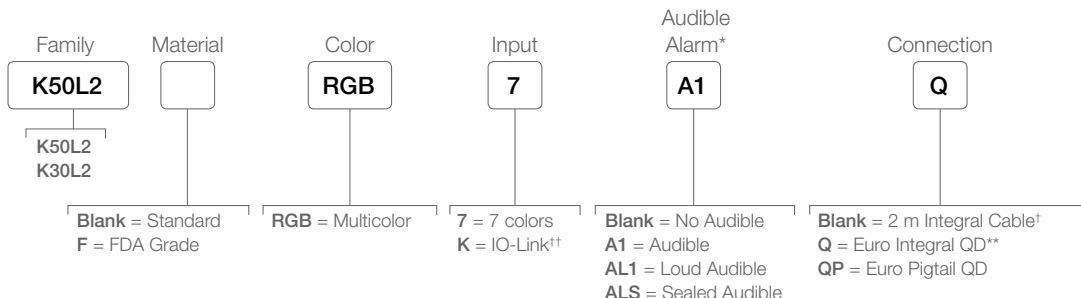

* Audible models not available in FDA-grade material
 ** Integral QD not available in FDA-grade material
 † IO-Link models not available with integral cable
 †† IO-Link not available in K30L2 models



Seven colors now available in one housing



SMB30FA



SMB22FVK

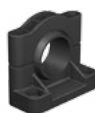

SMB30SC



SMB30A

K30L2 accessories listed on next page.





4- pin
Euro QD

MQDC-415
5 m (15')
MQDC-415RA
5 m (15')

Additional lengths available on bannerengineering.com

Specifications

Supply Voltage and Current	K50L2: 10 to 30 V dc; 220 mA Max. at 10 V dc; 100 mA Max. at 30 V dc K30L2: 10 to 30 V dc; 60 mA Max. at 10 V dc; 30 mA Max. at 30 V dc
Construction	Polycarbonate housing
Environmental Rating	K50L2: Standard: IEC IP66/IP67/IP69K Standard Audible: IEC IP50 Sealed Audible: IEC IP66/IP67/IP69K K30L2: IEC IP66/IP67/IP69K
Operating Temperature	-40 to 50 °C
Certifications	 

S22 Touch Series

Flat Touch Button



- Large, bright illuminated area for clear visibility of input and touch status
- Flush mount design sits tight against panel, machine and bracket surfaces
- Independent color control or preconfigured models to suit your indication needs
- Momentary versions remain activated as long as touch is present, while latching versions toggle between activated and not activated states on successive touches
- Excellent immunity to false triggering by water spray, detergents, oils, and other foreign materials
- Rugged, water-resistant IP69K design for washdown environments
- Ergonomically designed to eliminate hand, wrist and arm stresses, requiring no physical pressure to operate and can be actuated with bare hands or work gloves
- Applications see page 12, 19

Multipurpose Independent Control

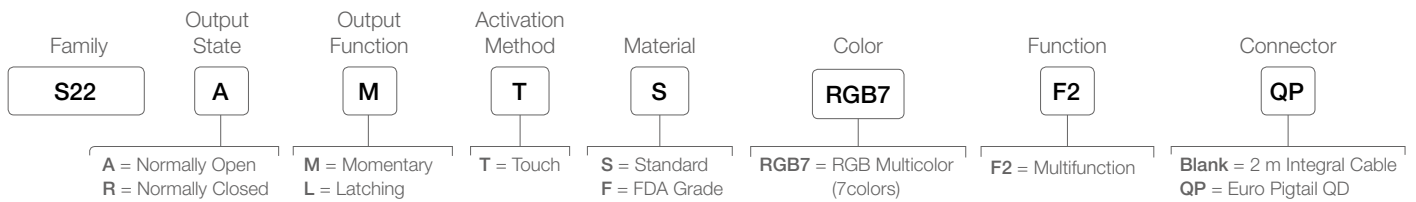

Illuminated Button Control

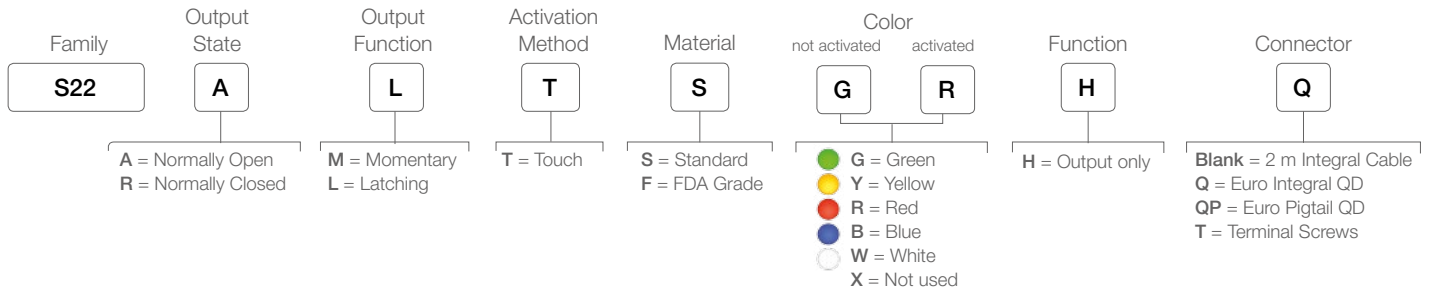

SMB22A



SMB22FVK



SMBAMS22P



SMB22RAVK



5-pin Euro QD



5-pin M12 Euro-Style Washdown Cordset
Straight connector models only

MQDC1-515
5 m (15')
MQDC1-515RA
5 m (15')

MQDC-WDSS-0515
5 m (15')

Additional lengths available on bannerengineering.com

Specifications

Supply Voltage	10 to 30 V dc
Supply Current	80 mA max current (exclusive of load)
Supply Protection Circuitry	Protected against reverse polarity and transient voltages
Construction	Housing: Polycarbonate or FDA grade plastic, depending on model Translucent dome: Polycarbonate or FDA grade plastic, depending on model Mounting Nut: PBT
Environmental Rating	Standard: UL Type 4x, 13 FDA Grade: UL Type 4x Cable, Pigtail, QD models: IEC IP66, IP67, IP69K per DIN 40050-9 on front and back Terminal models: IEC IP66, IP67, IP69K per DIN 40050-9 on front only
Connections	2 m PVC integral cable, integral Euro-style QD, 150 mm Euro-style pigtail QD or terminal
Operating Conditions	Temperature: -40 to +50 °C Storage Temperature: -40 to +70 °C

Certifications





LASER
MARKING
AVAILABLE

K70L Series

Medium-Sized Domed Indicator

- Bright, uniform indicator light
- All models have flashing input control
- Models are available with up to five colors in one device
- Rugged, water-resistant IP65-rated design
- 12 V to 30 V dc operations
- Wireless options available in either 900 MHz and 2.4 GHz ISM Bands
- Applications see page 37

Standard and Wireless

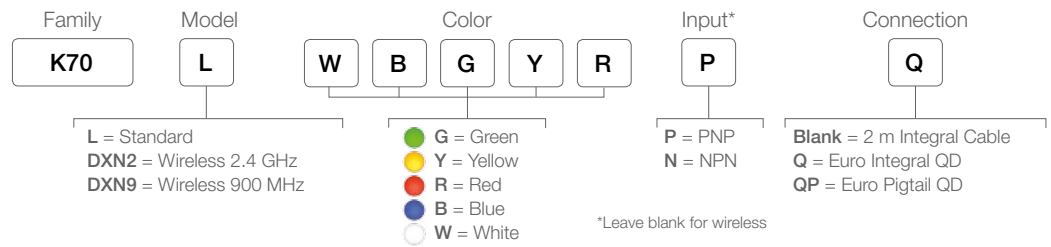

SMB30FA



SMB22FVK

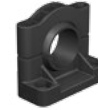

SMB30SC



SMB30A





4-pin
Euro QD

MQDC-415
5 m (15')
MQDC-415RA
5 m (15')

Additional lengths available on bannerengineering.com

Specifications

Supply Voltage and Current	K70L: 12 V to 30 V dc; 200 mA Max. at 12 V dc; 90 mA Max. at 30 V dc
Supply Protection Circuitry	Protected against reverse polarity, transient voltages
Construction	Polycarbonate housing
Environmental Rating	K70L: IEC IP65
Operating Temperature	-40 to 50 °C
Certifications	  Depending on model)

More Information Online

For the latest products, brackets, cordsets, accessories, and new solutions, find us on the web at www.bannerengineering.com.

You also have access to more detailed information such as engineering drawings, complete specifications, installation instructions, product configurators and product videos.

The screenshot shows the Banner Engineering website homepage. At the top is a navigation bar with the Banner logo and links for HOME, GLOBAL, MY LIBRARY, MY USER LIST, MY ACCOUNT, and MY CART. Below the navigation is a large hero section with the heading "PRODUCTS" and the text "Our product offering is unrivaled for quality, performance and depth." Below this are two columns of "Solutions" and "Industries" with brief descriptions. A "Remote Monitoring" section highlights "DATA-DRIVEN DECISIONS, GREATER VISIBILITY." Below this are "News & Events" featuring a video for "K30L2 & K50L2" and an article on "MACHINE SAFETY." At the bottom are four service icons: MY ACCOUNT, FACTORY TRAINING, GLOBAL WEBINARS, and NEWSLETTERS. A final banner at the bottom reads "QUALITY IN EVERYTHING" and features a worker in a hard hat.

How to Reach Us

Global Sales and Support

Questions? Need additional assistance?

Banner has more than 3,000 representatives and distributors worldwide — ready to help you. Our highly skilled application engineers and industry experts are ready to support you wherever you are. For a complete listing, go to bannerengineering.com and find your local Banner Representative.

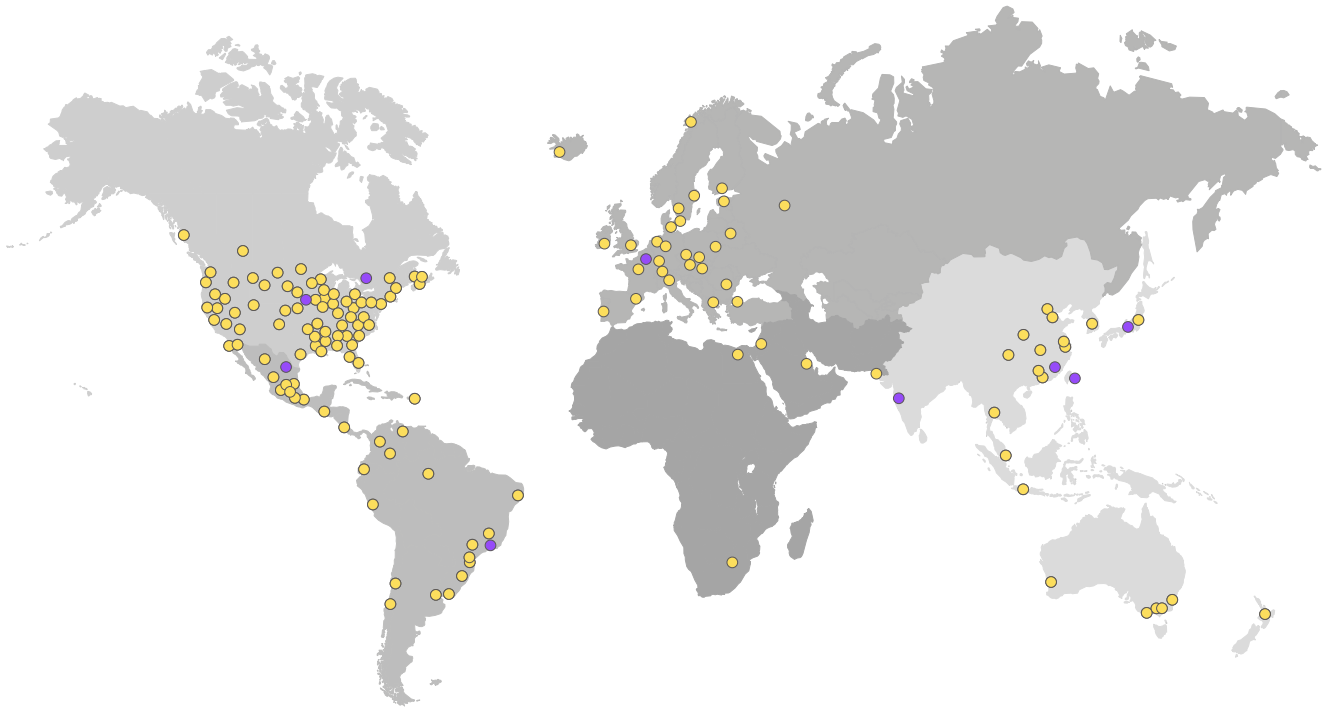

To contact a Banner Engineer about your application, call 1-888-3SENSOR (1-888-373-6767) or visit our website at www.bannerengineering.com/contact-us



more sensors, more solutions

9714 10th Ave. North
Minneapolis, MN 55441
Office: (763) 544-3164
www.bannerengineering.com